

DAIKIN

WIRED REMOTE CONTROLLER

INSTALLATION MANUAL

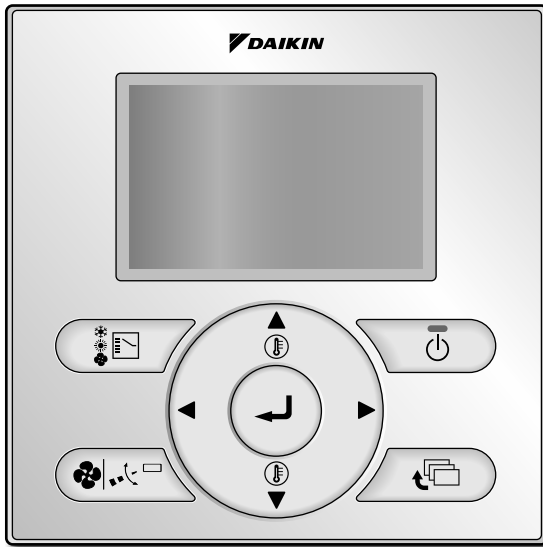

BRC1E52B7

**Be sure to read this installation manual before
conducting the installation of this product.**

Contents

1. Safety Precautions	2
2. Accessories	4
3. Remote controller installation procedure	4
4. Functions and menu items of remote controller buttons	10
5. Power-on	12
6. Field settings	13
7. Test operation method (in the case of SkyAir).....	16
8. Checking procedure of Error History	19
9. Registration method of the Maintenance Contact	20
10. Confirmation of registered details	21
11. Clock & Calendar	22
12. Language.....	23
13. Prohibit buttons	24
14. Prohibit Function.....	25



1. Safety Precautions

The original instructions are written in English. All other languages are translations of the original instructions.

■ Also see installation manual attached to the indoor unit.

Please read these "Safety Precautions" carefully before installing air conditioning equipment and be sure to install it correctly.

- The precautions described herein are classified as WARNING and CAUTION. They both contain important information regarding safety. Be sure to observe all precautions without fail.

 WARNING	Failure to follow these instructions properly may result in personal injury or loss of life.
 CAUTION	Failure to observe these instructions properly may result in property damage or personal injury, which may be serious depending on the circumstances.

- After completing installation, conduct a trial operation to check for faults and explain to the customer how to operate the air conditioner and take care of it with the aid of the operation manual. Ask the customer to store the installation manual along with the operation manual for future reference.

⚠ WARNING
Ask your dealer or qualified personnel to carry out installation work. Do not attempt to install the remote controller yourself. Improper installation may result in water leakage, electric shocks or fire.
Consult your local dealer regarding relocation and reinstallation of the remote controller. Improper installation work may result in leakage, electric shocks or fire hazards.
Install the remote controller in accordance with the instructions in this installation manual. Improper installation may result in water leakage, electric shocks or fire.
Be sure to use only the specified accessories and parts for installation work. Failure to use the specified parts may result in the unit falling, water leakage, electric shocks or fire.
Install the remote controller on a foundation strong enough to withstand the weight of the remote controller. A foundation of insufficient strength may result in the remote controller falling and causing injury.
Electrical work must be performed in accordance with relevant local and national regulations and with instructions in this installation manual. Be sure to use a dedicated power supply circuit only. Insufficiency of power circuit capacity and improper workmanship may result in electric shocks or fire.
Always perform installation work with the power supply shut-off. Touch with energized electric parts causes an electric shock.
Do not disassembly, reconstruct or repair. Electric shock and/or fire are caused.
Make sure that all wiring is secured, the specified wires are used, and that there is no strain on the terminal connections or wires. Improper connections or securing of wires may result in abnormal heat build-up or fire.
The choice of materials and installations must comply with the applicable national and international standards.

CAUTION

To avoid leakage and electric shock due to entry of water or insects, fill the wiring through hole with putty.

To avoid electric shocks, do not operate with wet hands.

Do not wash the remote controller with water, as this may result in electric shocks or fire.

Install the indoor and outdoor units, power cord and connecting wires at least 1 meter away from televisions or radios to prevent picture interference and noise.

(Depending on the incoming signal strength, a distance of 1 meter may not be sufficient to eliminate noise.)

Do not install the air conditioner in the following locations:







1. Where there is a high concentration of mineral oil spray or vapour (e.g. a kitchen).
Plastic parts will deteriorate, parts may fall off and water leakage could result.
2. Where corrosive gas, such as sulphurous acid gas, is produced.
Corroding of copper pipes or soldered parts may result in refrigerant leakage.
3. Near machinery emitting electromagnetic radiation.
Electromagnetic radiation may disturb the operation of the control system and result in a malfunction of the unit.
4. Where flammable gas may leak, where there is carbon fibre or ignitable dust suspensions in the air, or where volatile flammables such as paint thinner or gasoline are handled.
Operating the unit in such conditions may result in fire.
5. High temperature area or directly flamed point.
Heating and/or firing may be caused.
6. Moist area, or place where may be exposed to water.
If water enters inside of the remote controller, electric shock may be caused and inner electronics may fail.

When remote controller thermo function is used, select the installation location considering the followings.

- A place where average temperature in the room can be detected.
- A place where is not exposed to direct sunlight.
- A place where is far apart from heat source.
- A place where is not affected by outside air due to door opening/closing or the like.

2. Accessories

The following accessories are included.

Wood screw	Small screw	Clamp	Manual CD	Quick Reference	Wiring retainer
($\text{Ø}3.5 \times 16$) 2x 	(M4 \times 16) 2x 	1x 	1x 	1x 	1x 

3. Remote controller installation procedure

3-1 Determine where to install the remote controller.

Make sure to follow "1. Safety Precautions" when determining the location.

3-2 Make a wiring through hole on the wall if the wires are taken out from the back side.

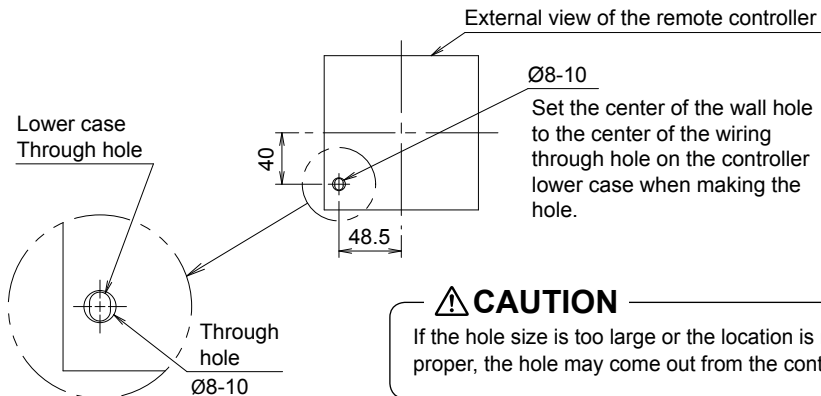

3-3 Remove upper case.

Insert a screwdriver in the recess of lower case to remove the upper case (2 points).

Remote controller PC-board is installed on the upper case. Take care not to damage the PC-board with the screwdriver.

Take care that dust or moisture does not touch the PC-board of removed upper case.

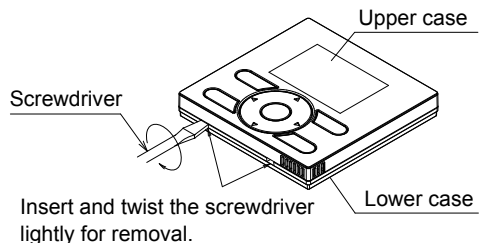

3-4 Determine the direction of controller wiring outlet (back outlet, left outlet, upper center outlet, upper outlet).

3-4-1 Back outlet

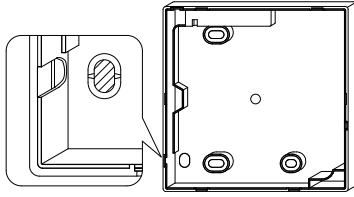

Cut off resin area (hatched area).

3-4-2 Left outlet

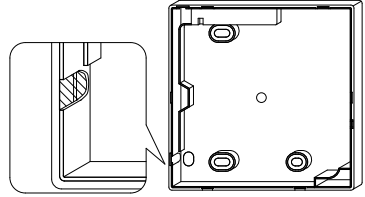

Cut off thin area (hatched area) with nippers or the like, and then remove burr with a file or the like.

3-4-3 Upper outlet

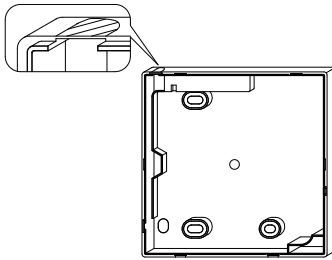

Cut off thin area (hatched area) with nippers or the like, and then remove burr with a file or the like.

3-4-4 Upper center outlet

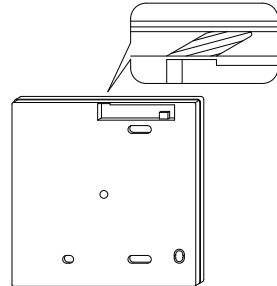

Cut off thin area (hatched area) with nippers or the like, and then remove burr with a file or the like.

3-5 Conduct wiring.

⚠ CAUTION

1. Switch box and transmission wiring are not attached.
2. Do not directly touch the remote controller PC-board.

Wiring Specifications

Wiring Type	Sheathed vinyl cord or cable
Wiring Size	0.75~1.25 mm ²

Sheath part in the remote controller case should be stripped.

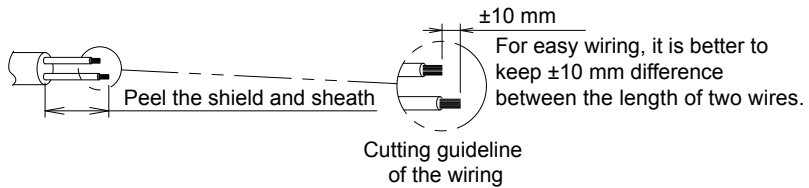

Sheath stripping length:

- ±150 mm for upper outlet
- ±200 mm for upper center outlet

Connect the terminals (P/P1, N/P2) of the remote controller upper case with the terminals (P1, P2) of the indoor unit. (P1 and P2 have no polarities.)

3-5-1 Back outlet

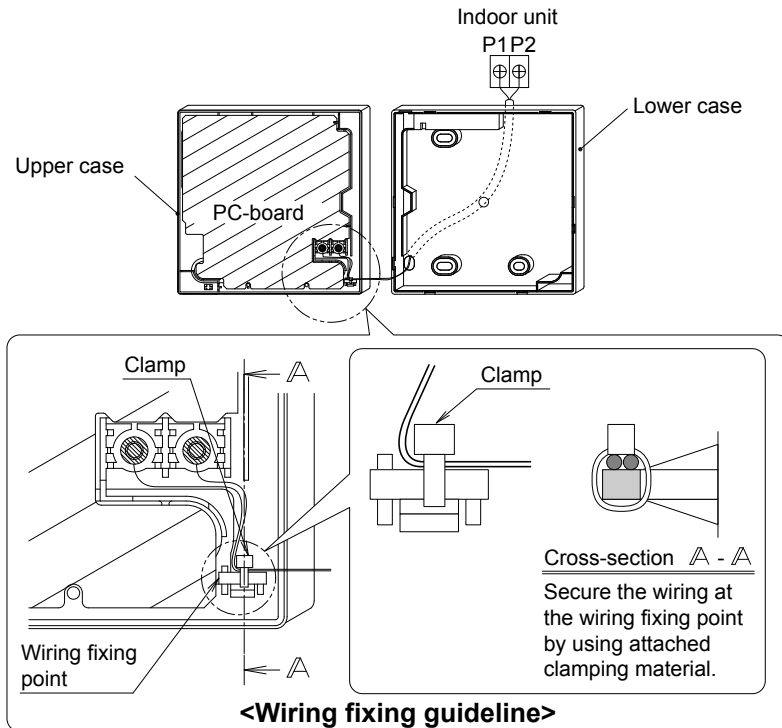

3-5-2 Left outlet

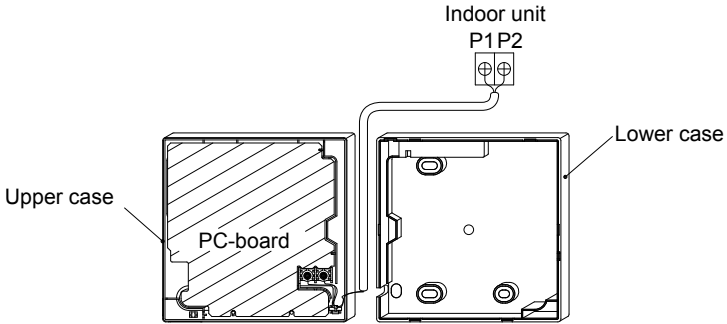

3-5-3 Upper outlet

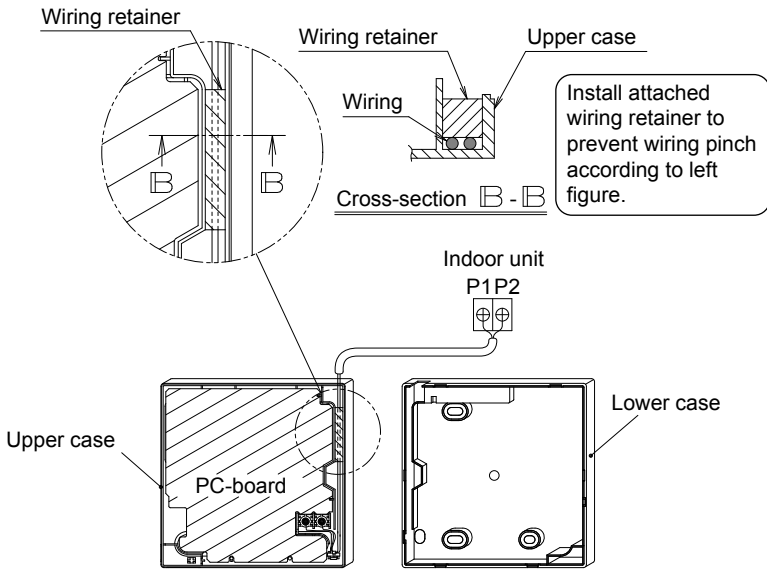

3-5-4 Upper center outlet

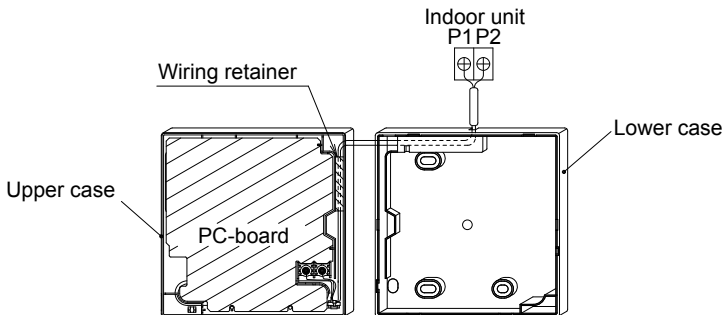

⚠ CAUTION

- Perform wiring apart from a power line not to receive electrical noise (external noise) during the wiring.
- Seal wiring draw-in port securely with putty (field supply) to prevent entry of insects or the like.

3-6 Fixing procedure of lower case.

In the case of wiring center upward drawing or rearward drawing, see wiring procedure first as wiring with the case is needed before fixing.

3-6-1 In the case of installation on the wall

Secure by using attached wood screws (2×).

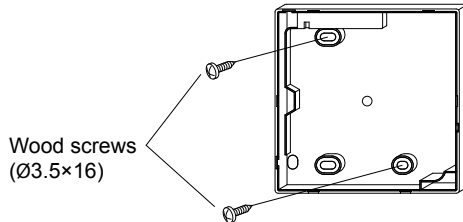

3-6-2 In the case of installation on the switch box

Secure by using attached small screws (2×).

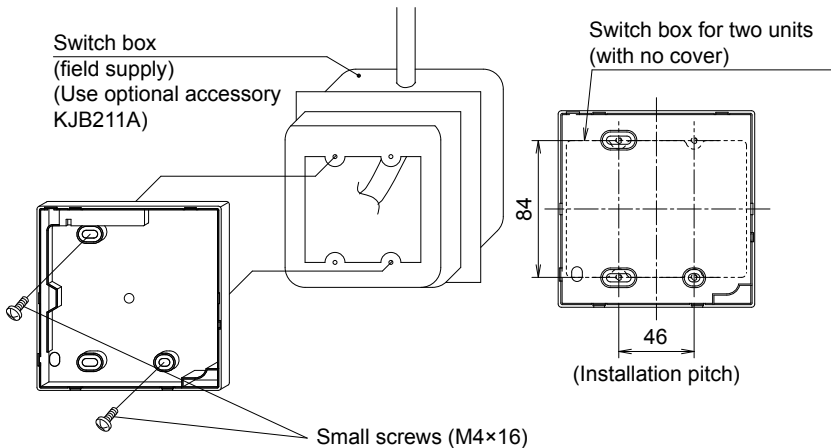

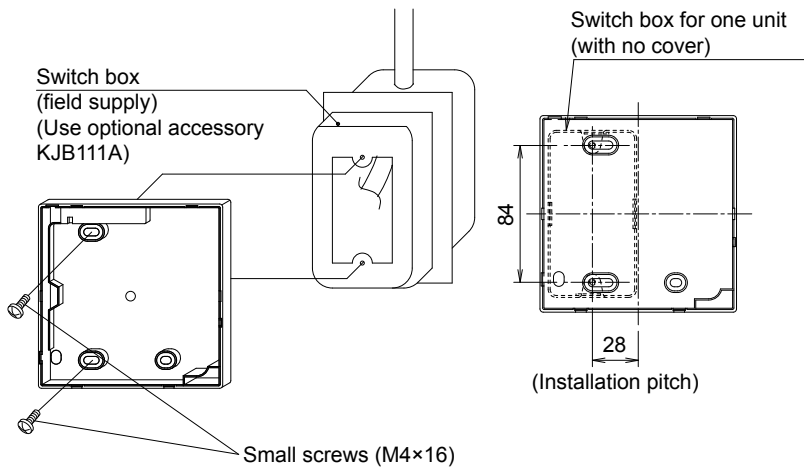

⚠ CAUTION

- Select flat place for installation face as possible.
- And, do not tighten the installation screws too much not to deform the lower case.

3-7 Install the upper case as original condition.

- Align the upper case with tabs of the lower case (6 points), inset and install the upper case.
- Install the wiring with care to prevent the pinch.
- Peel off a protective seal which is attached on the upper case.

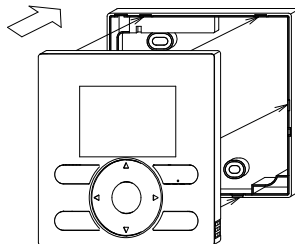

4. Functions and menu items of remote controller buttons

4-1 Functions and menu items

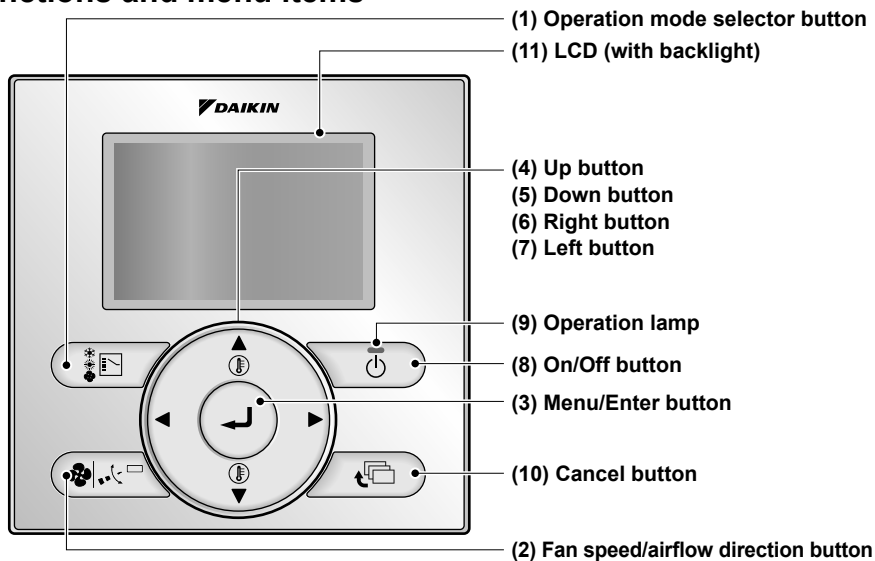

(1) Operation mode selector button

Used to change the mode.

(2) Fan speed/airflow direction button

Used to show the setting screen of Fan speed and Airflow direction.

(3) Menu/Enter button

- Used to indicate the main menu.
(For details of main menu, see the operation manual.)
- Used to enter the setting item selected.

Main menu

Air Flow Direction
Quick Start
Ventilation
Energy Saving Options
Schedule
Filter Auto Clean
Maintenance Information
Configuration
Current Settings
Clock & Calendar
Language

*Depending on connected model

(4) Up button ▲

- Used to raise the set temperature.
- The next items on the upper side will be highlighted.
(The highlighted items will be scrolled continuously when the button is kept pressed.)
- Used to change the item selected.

(5) Down button ▼

- Used to lower the set temperature.
- The next items on the lower side will be highlighted.
(The highlighted items will be scrolled continuously when the button is kept pressed.)
- Used to change the item selected.

(6) Right button ►

- Used to highlight the next items on the right-hand side.
- Display contents are changed to next screen per page.

(7) Left button ◀

- Used to highlight the next items on the left-hand side.
- Display contents are changed to previous screen per page.

(8) On/Off button

Press once to operate, and press once again to stop.

(9) Operation lamp

Green lamp lights up during operation. The lamp will blink if a malfunction occurs.

(10) Cancel button

- Used to return to the previous screen.
- Press and hold this button for 4 seconds or longer to display Service settings menu.

(11) LCD (with backlight)

The backlight will be lit for approximately 30 seconds by pressing any operation button.

Service Settings menu

- Test Operation
- Maintenance Contact
- Field Settings
- Min Setpoints Differential
- Group Address
- Indoor unit AirNet Address
- Outdoor unit AirNet Address
- Error History
- Indoor Unit Status
- Outdoor Unit Status
- Forced Fan ON
- Switch Main Sub Controller
- Filter Indicator
- Test Filter Auto Clean
- Brush/Filter Ind.
- Disable Filter Auto Clean

*Depending on connected model

⚠ CAUTION

- Operate the button during backlight lit. However, On/Off may be operated concurrently with backlight lit.
- When 1 indoor unit is controlled by 2 remote controllers, the remote controller backlight is lit which is operated first.
- To operate Up/Down/Left/Right button, always press ▲, ▼, ◀, or ▶.

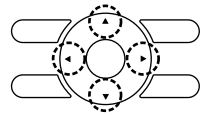

4-2 Displays for button operation descriptions

<Service Settings menu screen>

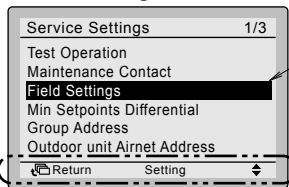

Highlighted display (selected items)

In the highlighted display (selected items setting screen, descriptions of button operation are displayed.

5. Power-on

- Check for completion of indoor/outdoor units wiring.
- Check for closing of switch box cover of indoor and outdoor units before power-on.

5-1 Followings are displayed after power-on.

"Checking the connection
Please stand by"

During above display, backlight does not light by button operation.

When 1 indoor unit is controlled by 2 remote controllers:

Be sure to set sub remote controller during above display. Press and hold 4 seconds or longer the Operation mode selector button of the remote controller to be set.

When the display is changed from main remote controller to sub remote controller, the setting is completed.

<Main remote controller>

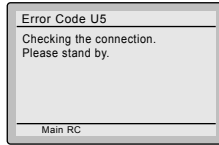

<Basic screen>

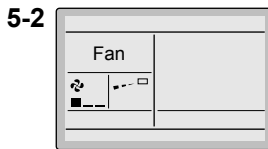

<Sub remote controller>

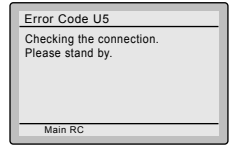
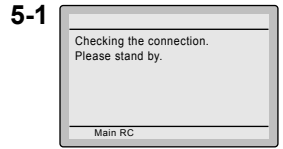

Press and hold 4 seconds or longer the Operation mode selector button of sub remote controller side.

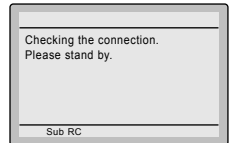

<Basic screen>

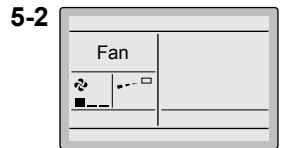

5-2 Basic screen is displayed.

CAUTION

If sub remote controller is not set at power-on in the case of one indoor unit controlled by two remote controllers, "Error code: U5" is displayed in the connection checking screen.

Select the sub remote controller by pressing the Operation mode selector button of either one of the remote controllers for 4 seconds or longer.

If the basic screen is not displayed more than 2 minutes after "sub remote controller" display, shut off the power supply and check the wiring.

NOTE

When selecting a different language, refer to **12. Language**. (See page 23.)

6. Field settings

6-1 Press and hold Cancel button for 4 seconds or longer.
Service Settings menu is displayed.

6-2 Select **Field settings** in the Service Settings menu, and press Menu/Enter button.
Field settings screen is displayed.

6-3 Highlight the mode, and select desired "Mode No." by using ▲▼ (Up/Down) button.

6-4 In the case of setting per indoor unit during group control (When Mode No. such as **20**, **21**, **22**, **23**, **25** are selected), highlight the unit No. and select "Indoor unit No." to be set by using ▲▼ (Up/Down) button. (In the case of group setting, this operation is not needed.)

In the case of individual setting per indoor unit, current settings are displayed. And, SECOND CODE NO. "-" means no function.

6-5 Highlight SECOND CODE NO. of the FIRST CODE NO. to be changed, and select desired "SECOND CODE NO." by using ▲▼ (Up/Down) button. Multiple identical mode number settings are available.

In the case of group setting, all of SECOND CODE NO. which may be set are displayed as "* *". "* *" is changed to SECOND CODE NO. to be set. And, SECOND CODE NO. "-" means no function.

<Basic screen>

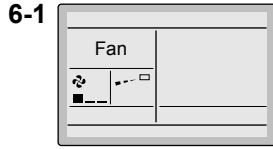

Press and hold Cancel button for 4 seconds or longer during backlight lit.



<Service Settings menu screen>

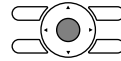
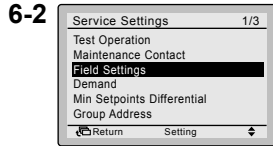

Press Menu/Enter button.



<Field settings screen>

In the case of individual setting per indoor unit

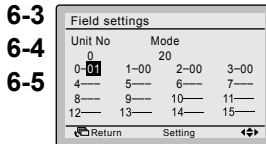

In the case of group setting

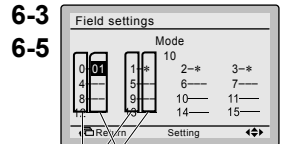

SECOND CODE NO.
FIRST CODE (SW) NO.



Press Menu/Enter button.

6-6 Press Menu/Enter button. Setting confirmation screen is displayed.



6-7 Select **Yes** and press Menu/Enter button. Setting details are saved and Field settings screen returns.

<Setting confirmation screen>

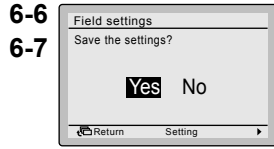

6-8 In the case of multiple setting changes, repeat "6-3" to "6-7".

6-9 After all setting changes are completed, press Cancel button twice.



Press Menu/Enter button.



Setting confirmation

6-10 Backlight goes out, and "Checking the connection Please stand by" is displayed during initialization. After the initialization, the basic screen returns.

CAUTION

- When an optional accessory is installed on the indoor unit, settings of the indoor unit may be changed. See the manual of the optional accessory.
- For field setting details of the outdoor unit, see installation manual attached to the outdoor unit.

Mode No. Note) 1	FIRST CODE NO.	Description of setting		SECOND CODE NO. Note) 2					
				01	02	03	04		
10 (20)	0	Filter Contamination - Heavy/Light (Setting for spacing time of display time to clean air filter) (Setting for when filter contamination is heavy, and spacing time of display time to clean air filter is to be halved)	Ultra long life filter	Light	±10.000 hrs.	Heavy	±5.000 hrs.	—	—
			Long life filter		±2.500 hrs.		±1.250 hrs.		
			Standard filter		±200 hrs.		±100 hrs.		
	1	Long-life filter type (setting of filter sign indication time). (Change setting when ultra-long filter is installed)	Long-life filter	Ultra-long life filter	—	—			
2	Thermostat sensor in remote controller	Use	Not use	—	—				
3	Spacing time of display time to clean air filter count (setting for when the filter sign is not to be displayed)	Display	Do not display	—	—				
11 (21)	0	Setting number of connected Sky Air simultaneous operation system indoor units (setting for simultaneous operations system)	Pair	Twin	Triple	Double twin			

Mode No. Note) 1	FIRST CODE NO.	Description of setting	SECOND CODE NO. Note) 2			
			01	02	03	04
12 (22)	1	ON/OFF input from outside (setting for when forced ON/OFF is to be operated from outside).	Forced OFF	ON/OFF operation	—	—
	2	Thermostat differential changeover (setting for when using remote sensor).	1°C	0.5°C	—	—
13 (23)	0	High air outlet velocity (for high ceiling applications).	≤2.7m	>2.7≥3.0m	>3.0≥3.5m	—
	1	Selection of airflow direction (setting for when a blocking pad kit has been installed).	4-way flow	3-way flow	2-way flow	—
	3	Selection of airflow function (setting for when using a decoration panel for outlet).	Equipped	Not equipped	—	—
	4	Airflow direction range setting.	Upper	Normal	Lower	—
	6	Setting the external static pressure (setting according to the connected duct resistance) (for FHYK, follow the high ceiling setting)	Normal (Normal)	High static pressure (High ceiling)	Low static pressure —	—
15 (25)	3	Drain pump operation with humidifying.	Equipped	Not equipped	—	—
1c	1	Thermostat sensor in remote controller (for Auto mode and Setback function only)	Not use	Use	—	—
1e	2	Setback function	Not use	Heat only	Cool only	Cool and Heat

Notes)

1. Though setting is performed totally in the group, set Mode No. in the parenthesis when individual setting per indoor unit or checking after the setting should be performed.
2. SECOND CODE NO. at factory shipment is set to "01". However for the following cases it is set to "02".
 - Airflow direction range setting (except round flow cassette)
 - Thermostat sensor in remote controller (SkyAir only)
 - Thermostat sensor in remote controller for auto mode operation and Setback function only
3. Any function which the indoor unit does not have is not displayed.

7. Test operation method (in the case of SkyAir)

* In the case of VRV, see the manual attached to the outdoor unit.

Also see installation manuals attached to the indoor unit and the outdoor unit.

- Check that wiring work of the indoor unit and the outdoor unit is completed.
- Check that switch box cover of the indoor unit and the outdoor unit is closed.
- After refrigerant piping, drain piping and electric wiring are completed, clean inside of the indoor unit and decorative panel.
- Perform the test operation according to following procedure.

7-1 Make sure to turn on the power supply more than 6 hours before operation start with front panel closed to protect compressor.

7-2 Confirm that stop valves of both liquid and gas are opened.

<Make sure that outer panel and piping cover is closed before operation (danger of electric shock). >

* After air purge by vacuum pump, refrigerant pressure may not rise even though the stop valve is opened. The reason is that refrigerant system of the outdoor unit is blocked by electrical expansion valve or the like. Operation is no problem.

7-3 Set the operation mode to cooling by using the remote controller.

7-4 Press and hold Cancel button for 4 seconds or longer. Service Settings menu is displayed.

7-5 Select **Test operation** in the Service Settings menu, and press Menu/Enter button. Basic screen returns and "Test operation" is displayed.

Notes for backlight

- The backlight will be lit for approximately 30 seconds by pressing any operation button.
- Operate the buttons during the backlight lit. However, On/Off can be operated concurrently with the backlight lit.

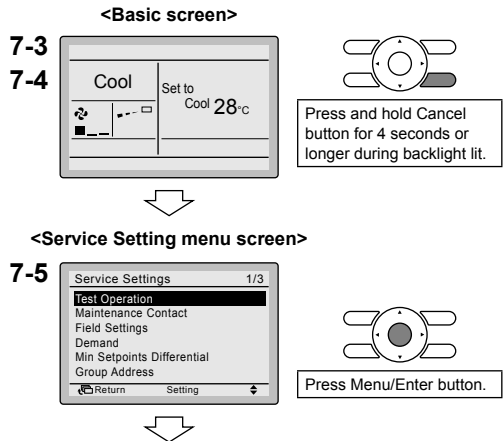

7-6 Press On/Off button within about 10 seconds. The test operation starts. Check operation condition for 3 minutes.

* Note) In the case of above-mentioned procedures 7-5 and 7-6 in reverse order, test operation can start as well.

7-7 Press Fan speed/airflow direction button.

7-8 Select airflow direction setting by pressing the ► button on the setting screen. Use the ▲▼ buttons to change the airflow direction.

7-9 After the operation of airflow direction is confirmed, press Menu/Enter button. Basic screen returns.

7-10 Press and hold Cancel button for 4 seconds or longer in the basic screen. Service Settings menu is displayed.

7-11 Select **Test operation** in the Service Settings menu, and press Menu/Enter button. Basic screen returns and normal operation is conducted.



7-12 Check the functions according to the operation manual.

7-13 When the decorative panel is not installed, shut off the power supply after the test operation finishes.

- If interior work is not completed after the test operation finish, explain to the customer that operation should not be performed until the interior work completion to protect the indoor unit.

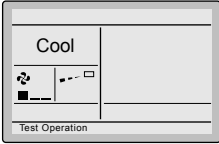

(If the operation is performed, the indoor unit may be contaminated with the materials which arise from paints or adhesives during the interior work, and water splash or water leak may occur.)

7-6

Press On/Off button (within 10 seconds).

7-7

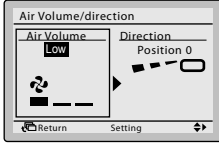



Press Fan speed/airflow direction button.

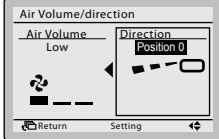

To select airflow direction setting, press ► (Right) button on the setting screen.

7-9





Change the airflow direction by using ▲▼ (Up/Down) button.



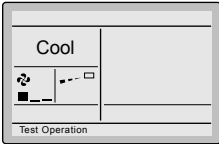

Press Menu/Enter button.

7-10

Press and hold Cancel button for 4 seconds or longer during backlight lit.

7-11

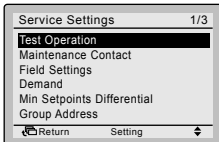
Press Menu/Enter button.

<Basic screen>

⚠ CAUTION

- If operation is not available due to any malfunction, refer to following **Failure diagnosis method**.
- After the test operation finishes, check that error code record is not displayed in the Maintenance Information screen of the main menu according to the following procedure.

7-14 Press Menu/Enter button in the basic screen. Main menu screen is displayed.

7-15 Select **Maintenance Information** in the main menu, and press Menu/Enter button.

7-16 Maintenance Information screen is displayed. Check that error code record is not displayed in the screen.
* Screen which does not display the error code record means normal status.

7-17 If the error code record is displayed, conduct the failure diagnosis referring to <Error code list> in the installation manual of the indoor unit.
After the failure diagnosis finishes, press and hold On/Off button for 4 seconds or longer in the "Maintenance Information" screen to erase the error code record.

<Basic screen>

7-14

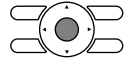
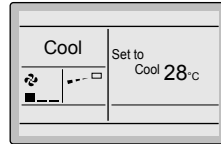

Press Menu/Enter button.

<Main menu screen>

7-15

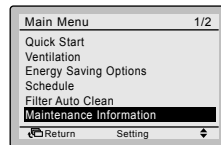

Press Menu/Enter button.

7-16

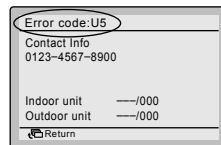

7-17



Press and hold On/Off button for 4 seconds or longer during backlight lit.

Failure diagnosis method

- When the remote controller displays any item in following table, inspect the details in the table.
- If an error occurs, "code" is displayed in the LCD like right figure.
Conduct the failure analysis referring to "Error code list" in the installation manual of the indoor unit.
And when the unit No. which detected the error during group control is confirmed, refer to "**8. Checking procedure of Error History**".

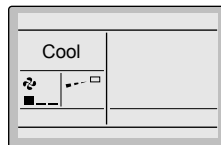

Remote controller display	Description
No display	<ul style="list-style-type: none"> ● Power outage, power voltage error or open-phase ● Wrong wiring (between indoor and outdoor units) ● Indoor PC-board assembly failure ● Remote controller wiring disconnection ● Remote controller failure ● Fuse blown (outdoor unit)
Display of "Checking the connection Please stand by" is turned on. *	<ul style="list-style-type: none"> ● Indoor PC-board assembly failure ● Wrong wiring (between indoor and outdoor units)

* Though "Checking the connection

Please stand by" is displayed for 90 seconds at maximum after power-on, this does not mean a failure. (Determine after 90 seconds.)

8. Checking procedure of Error History

8-1 Press and hold Cancel button for 4 seconds or longer in the basic screen. Service Settings menu is displayed.

8-2 Select **Error History** in the Service Settings menu, and press Menu/Enter button. The Error History menu screen is displayed.

8-3 Select **RC Error History** in the Error History menu, and press Menu/Enter button. Error codes and unit No. can be confirmed in the error record display screen.

8-4 In the Error History, 10 items from the latest are displayed in order.

8-5 Press Cancel button in the Error History display screen 3 times. The basic screen returns.

8-1 <Basic screen>



<Service Settings menu screen>

8-2

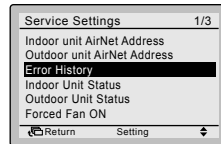

Press Menu/Enter button.



8-3

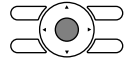
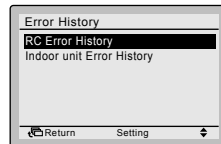

Press Menu/Enter button.

8-4

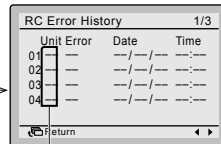

8-5

Unit No.

Latest record

9. Registration method of the Maintenance Contact

- Registration of the service contact.

- 9-1** Press and hold Cancel button for 4 seconds or longer in the basic screen.
Service Settings menu is displayed.
- 9-2** Select **Maintenance Contact** in the Service Settings menu, and press Menu/Enter button. "Maintenance Contact" menu screen is displayed.
- 9-3** Select **Maintenance Contact**, and press Menu/Enter button.
- 9-4** Enter the telephone number.
Numeric varies by using ▲▼ (Up/Down) button. Enter from the left end, and blank digit should be left as " -".
- 9-5** Press Menu/Enter button.
Setting confirmation screen is displayed.
- 9-6** Select **Yes** and press Menu/Enter button.
Setting details are determined and Service Settings menu screen returns.
- 9-7** Press Cancel button once.
The basic screen returns.

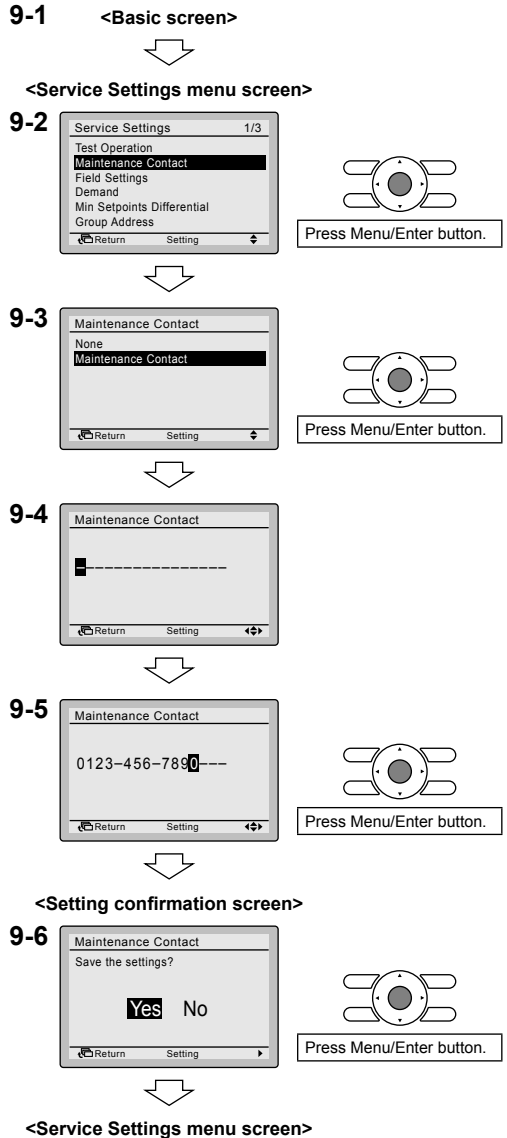

10. Confirmation of registered details

- 10-1** Press Menu/Enter button in the basic screen.
Main menu is displayed.
Select **Maintenance Information** in the main menu, and press Menu/Enter button.

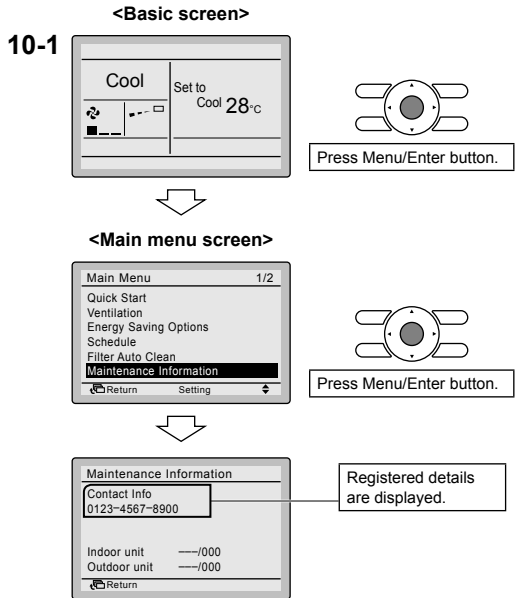

11. Clock & Calendar

11-1 Press Menu/Enter button in the basic screen.
Main menu is displayed.
Select **Clock & Calendar** in the main menu, press Menu/Enter button.

11-2 Press **▲▼** buttons to select **Date & Time** on the clock & calendar screen.
* The date & time screen will appear when the Menu/Enter button is pressed.

11-3 Select "Year", "Month", "Day" and time by using **◀▶** (Left/Right) button and set by using **▲▼** (Up/Down) button in the clock setting screen. During the button is pressed and held, numeric changes continuously.
* Day of the week is set automatically.

11-4 Press Menu/Enter button.
Setting confirmation screen is displayed.

11-5 Select **Yes** and press Menu/Enter button.
Setting details are confirmed and basic screen returns.

* If duration of power outage exceeds 48 hours, reset is needed.

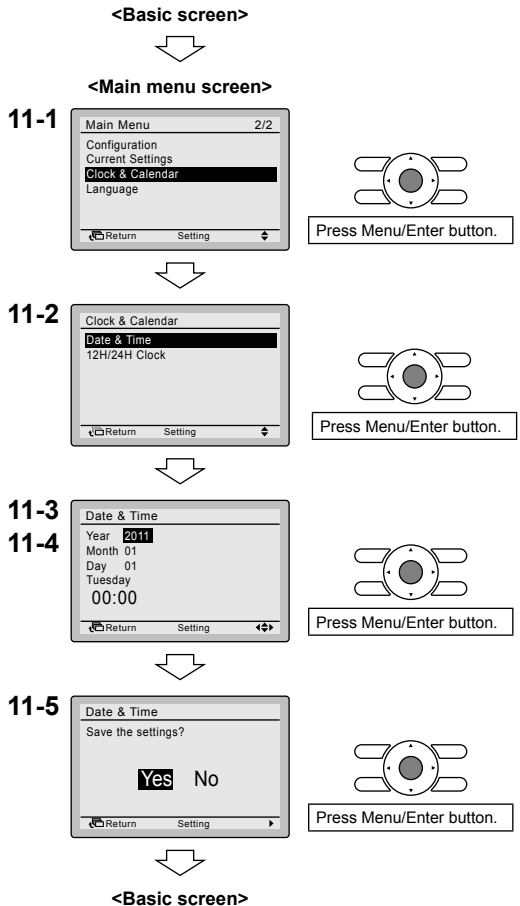

12. Language

12-1 Press Menu/Enter button in the basic screen.

Main menu is displayed.

Select **Language** in the main menu, press Menu/Enter button.

12-2 Press ▲▼ (Up/Down) buttons to select "Language" on the Language screen.

English/Deutsch/Shqip/Български/
Hrvatski/Česky/Magyar/Română/
Srpski/Slovenčina/Slovenščina

Pressing Menu/Enter button.

Setting details are confirmed and basic screen returns.

<Basic screen>



<Main menu screen>

12-1

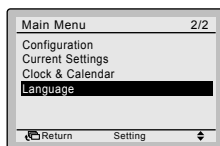

Press Menu/Enter button.



12-2

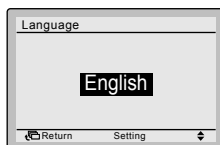

13. Prohibit buttons

- Restriction of the number of operable buttons.

13-1 Press Menu/Enter button in the basic screen.
Main menu is displayed.
Normally, "Lock function" is not shown in main menu.
Press Menu/Enter button for 4 seconds to display the "Lock function".

13-2 Select **Lock function** in the main menu, press Menu/Enter button.

13-3 Select **Prohibit buttons** in the menu, press Menu/Enter button.

13-4 Select "Up/Down/L/R", "On/Off", "Mode", Fan Speed" by using ◀▶ (Left/Right) button and set by using ▲▼ (Up/Down) button.

13-5 Press Menu/Enter button.
Setting confirmation screen is displayed.

13-6 Select **Yes** and press Menu/Enter button.
Setting details are confirmed and basic screen returns.

If you want to restrict the number of operable buttons on the remote controller to be defined as "sub", start with only connecting this controller to the unit. Make sure that this controller is set to "main" (factory set) first, change the restrictions to the setting you prefer and only then set the remote controller to "sub".

13-7 To lock menu button in basic screen, proceed as follows:
1. Keep the ▶ button pressed.
2. And push the 3 other indicated keys simultaneously while keeping the ▶ button pressed.

To unlock menu button in basic screen, follow the same procedure.

NOTE: When pushing a prohibit button, the  will be displayed.

<Basic screen>



<Main menu screen>

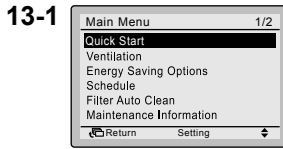

Press Menu/Enter button for 4 seconds.

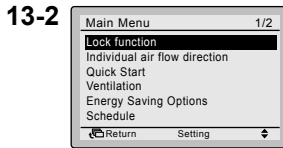

Press Menu/Enter button.

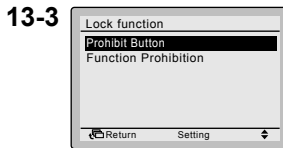

Press Menu/Enter button.

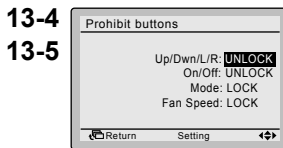

Press Menu/Enter button.

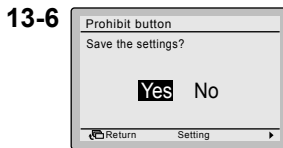

Press Menu/Enter button.



<Basic screen>

13-7

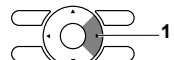

14. Prohibit Function

- Restriction of the number of operable functions.

14-1 Press Menu/Enter button in the basic screen.

Main menu is displayed.

As usual, "Lock function" is not shown in main menu.

Press Menu/Enter button for 4 seconds to display the "Lock function".

14-2 Select **Lock function** in the main menu, press Menu/Enter button.

14-3 Select **Function Prohibition** in the menu, press Menu/Enter button.

14-4 Select function by using ◀▶ (Left/Right) button and set by using ▲▼ (Up/Down) button.

14-5 Press Menu/Enter button. Setting confirmation screen is displayed.

14-6 Select **Yes** and press Menu/Enter button. Setting details are confirmed and basic screen returns.

If you want to restrict the number of operable functions on the remote controller to be defined as "sub", start with only connecting this controller to the unit. Make sure that this controller is set to "main" (factory set) first, change the restrictions to the setting you prefer and only then set the remote controller to "sub".

NOTE: When a function is prohibited, the  will be displayed next to the function in the main menu screen.

<Basic screen>



<Main menu screen>

14-1

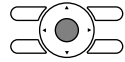
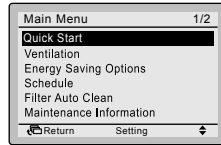

Press Menu/Enter button for 4 seconds.



14-2

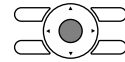
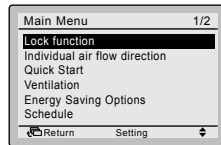

Press Menu/Enter button.



14-3

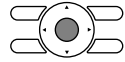
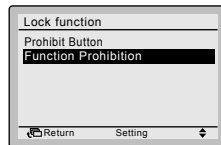

Press Menu/Enter button.



14-4

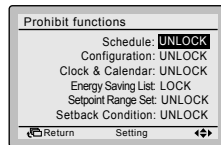

Press Menu/Enter button.

14-5



14-6

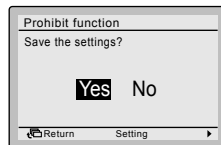

Press Menu/Enter button.



<Basic screen>

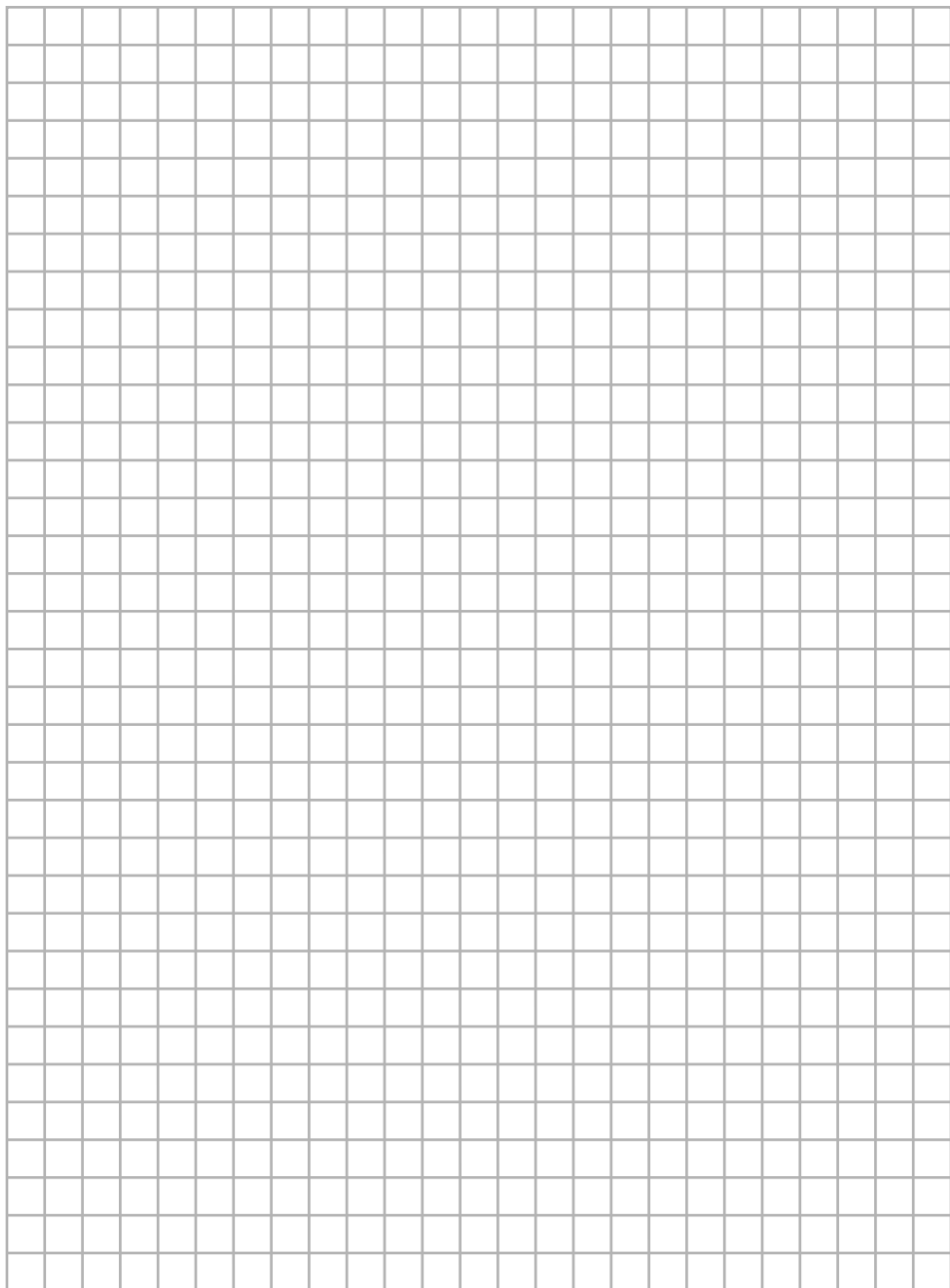

DAIKIN EUROPE N.V.

Zandvoordestraat 300, B-8400 Oostende, Belgium

Copyright 2011 Daikin