

**DAIKIN**

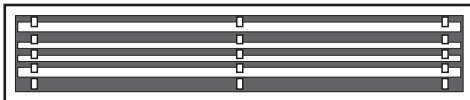

# INSTALLATION MANUAL

**R410A Split series**



English

Deutsch

Français

Nederlands

Español

Italiano

Ελληνικά

Portgues

Русский

Türkçe

FDXS25F2VEB  
FDXS35F2VEB  
FDXS50F2VEB  
FDXS60F2VEB  
FDXS50F2VEB9





# SAFETY PRECAUTIONS



The original instructions are written in English. All other languages are translations of the original instructions.

- Read these Safety Precautions carefully to ensure correct installation.
- This manual classifies the precautions into WARNING and CAUTION.  
Be sure to follow all the precautions below: they are all important for ensuring safety.



**⚠ WARNING** .....Failure to follow any of WARNING is likely to result in such grave consequences as death or serious injury.



**⚠ CAUTION** .....Failure to follow any of CAUTION may in some cases result in grave consequences.

- The following safety symbols are used throughout this manual:

 Be sure to observe this instruction.	 Be sure to establish an earth connection.	 Never attempt.
--	---	--





- After completing installation, test the unit to check for installation errors. Give the user adequate instructions concerning the use and cleaning of the unit according to the Operation Manual.

<b>⚠ WARNING</b>	
• Installation should be left to the dealer or another professional. Improper installation may cause water leakage, electrical shock, or fire.	
• Install the air conditioner according to the instructions given in this manual. Incomplete installation may cause water leakage, electrical shock, or fire.	
• Be sure to use only the specified accessories and spare parts for installation work. Failure to use the specified parts may result in the unit falling, water leakage, electric shocks or fire.	
• Install the air conditioner on a solid base that can support the weight of the unit. An inadequate base or incomplete installation may cause injury in the event the unit falls off the base.	
• Electrical work should be carried out in accordance with the installation manual and the national electrical wiring rules or code of practice. Insufficient capacity or incomplete electrical work may cause electrical shock or fire.	
• Be sure to use a dedicated power circuit. Never use a power supply shared by another appliance.	
• For wiring, use a cable length enough to cover the entire distance with no connection. Do not use an extension cord. Do not put other loads on the power supply, use a dedicated power circuit. (Failure to do so may cause abnormal heat, electric shock or fire.)	
• Use the specified types of wires for electrical connections between the indoor and outdoor units. Firmly clamp the interconnecting wires so their terminals receive no external stresses. Incomplete connections or clamping may cause terminal overheating or fire.	
• After connecting interconnecting and supply wiring be sure to shape the cables so that they do not put undue force on the electrical covers or panels. Install covers over the wires. Incomplete cover installation may cause terminal overheating, electrical shock, or fire.	
• When installing or relocating the system, be sure to keep the refrigerant circuit free from substances other than the specified refrigerant (R410A), such as air. (Any presence of air or other foreign substance in the refrigerant circuit causes an abnormal pressure rise or rupture, resulting in injury.)	
• If any refrigerant has leaked out during the installation work, ventilate the room. (The refrigerant produces a toxic gas if exposed to flames.)	
• After all installation is complete, check to make sure that no refrigerant is leaking out. (The refrigerant produces a toxic gas if exposed to flames.)	
• During pump-down, stop the compressor before removing the refrigerant piping. If the compressor is still running and the shut-off valve is open during pump-down, air will be sucked in when the refrigerant piping is removed, causing abnormal pressure in the freezer cycle which will lead to breakage and even injury.	
• During installation, attach the refrigerant piping securely before running the compressor. If the compressor is not attached and the shut-off valve is open during pump-down, air will be sucked in when the compressor is run, causing abnormal pressure in the freezer cycle which will lead to breakage and even injury.	
• When carrying out piping connection, take care not to let air substances other than the specified refrigerant go into refrigeration cycle. Otherwise, it will cause lower capacity, abnormal high pressure in the refrigeration cycle, explosion and injury.	
• Be sure to establish an earth. Do not earth the unit to a utility pipe, arrester, or telephone earth. Incomplete earth may cause electrical shock, or fire. A high surge current from lightning or other sources may cause damage to the air conditioner.	
• Be sure to install an earth leakage breaker. Failure to install an earth leakage breaker may result in electric shocks, or fire.	

<b>⚠ CAUTION</b>	
• Do not install the air conditioner in a place where there is danger of exposure to inflammable gas leakage. If the gas leaks and builds up around the unit, it may catch fire.	
• Establish drain piping according to the instructions of this manual. Inadequate piping may cause flooding.	
• Tighten the flare nut according to the specified method such as with a torque wrench. If the flare nut is tightened too hard, the flare nut may crack after a long time and cause refrigerant leakage.	
• Only handle the indoor unit with gloves.	

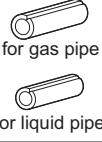
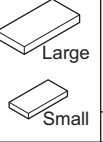
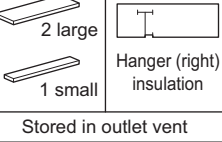
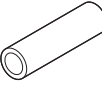
- This appliance is intended to be used by expert or trained users in shops, in light industry and on farms, or for commercial and household use by lay persons.
- Sound pressure level is less than 70 dB (A).

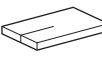
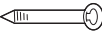
# ACCESSORIES

Clamp metal	Insulation for fitting	Sealing pad		Drain hose	Washer for hanging bracket	Sealing material	Clamp	Washer fixing plate	Screws for duct flanges
1 pc.	1 each	Large and small 1 each	3 pcs. (only for 50-60 type)	1 pc.	8 pcs.	2 pcs.	6 pcs.	1 set	1 set
									
			Stored in outlet vent					4 pcs.	24 pcs.

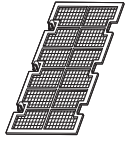
Air filter	[ Other ]
1 pc.	
	<ul style="list-style-type: none"> <li>• Operation manual</li> <li>• Installation manual</li> </ul>

## Optional accessories

- This indoor unit requires one of remote controllers.
- There are two type of remote controller: wired and wireless.  
Select a remote controller according to customers request and install in an appropriate place  
Refer to catalogues and technical literature for selecting a suitable remote controller

# CHOOSING A SITE

- Before choosing the installation site, obtain user approval.

## Indoor unit

### ⚠ Caution

- When moving the unit during or after unpacking, make sure to lift it by holding its lifting lugs. Do not exert any pressure on other parts, especially the refrigerant piping, drain piping and flange parts.  
Wear protective gears (gloves and so on) when installing the unit.
- If you think the humidity inside the ceiling might exceed 30°C and RH80%, reinforce the insulation on the unit body.  
Use glass wool or polyethylene foam as insulation so that the thickness is more than 10mm and fits inside the ceiling opening.

- Optimum air distribution is ensured.
- The air passage is not blocked.
- Condensate can drain properly.
- The ceiling is strong enough to bear the weight of the indoor unit.
- A false ceiling does not seem to be at an incline.
- Sufficient clearance for maintenance and servicing is ensured.
- Piping between the indoor and outdoor units is within the allowable limits.  
(Refer to the installation manual for the outdoor unit.)
- The indoor unit, outdoor unit, power supply wiring and transmission wiring is at least 1 meter away from televisions and radios. This prevents image interference and noise in electrical appliances. (Noise may be generated depending on the conditions under which the electric wave is generated, even if a one-meter allowance is maintained.)
- The equipment is not intended for use in a potentially explosive atmosphere.

### ■ Use suspension bolts to install the unit. Check whether or not the ceiling is strong enough to support the weight of the unit. If there is a risk that the ceiling is not strong enough, reinforce the ceiling before installing the unit.

Select the \*H dimension such that a downward slope of at least 1/100 is ensured as indicated in "DRAIN PIPING WORK".

- To avoid contact with the fan, one of the following precaution actions must be taken:
  - Install the unit as high as possible at a minimum bottom height of 2.7 m.
  - Install the unit as high as possible at a minimum bottom height of 2.5 m in case the fan is externally screened by parts which can be removed without the aid of tools (e.g. false sealing, grill ...).
  - Install the unit with ducting and grill which can only be removed with the aid of tooling. It shall be installed so that it gives adequate protection against touching the fan. If a maintenance panel exists in the ducting, it shall only be possible to remove the panel by the aid of tooling to avoid contact with the fan. The protection shall be according to relevant European and local legislation. There are no restrictions concerning the installation height.

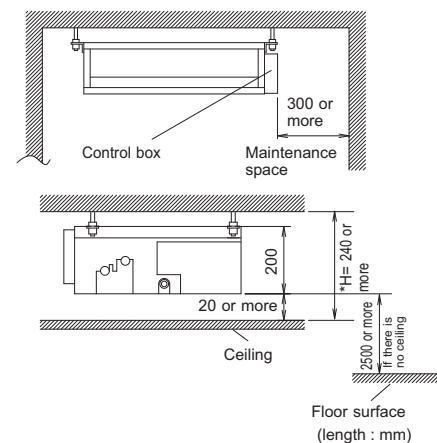

# CHOOSING A SITE

## ■ Select the signal receiver mounting location according to the following conditions:

- Install the signal receiver, which has a built-in temperature sensor, near the intake vent where there is convection of air and it can get an accurate reading of the room's temperature. If the intake vent is in another room or the unit cannot be installed near the intake vent for any other reason, install it 1.5m above the floor on a wall where there is convection.
- In order to get an accurate reading of the room's temperature, install the signal receiver in a location where it is not exposed directly to cold or hot air from the air discharge grille or to direct sunlight.
- Since the receiver has a built-in light receptor to receive signals from the wireless remote controller, do not mount it in a location where the signal may be blocked by a curtain, etc.

Air discharge grille:  
Wooden or plastic grille is recommended because condensation may occur depending on humidity conditions.

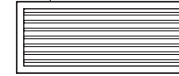

## ⚠ Caution

If the signal receiver is not installed in a location where there is convection of air, it may be unable to get an accurate reading of the room's temperature.

### Wireless remote controller

- Turn on all the fluorescent lamps in the room, if any, and find the site where remote controller signals are properly received by the indoor unit (within 4 metres).

### Outdoor unit

- For outdoor unit installation, see the installation manual supplied with the outdoor unit.

# PREPARATIONS BEFORE INSTALLATION

## ■ Relation of the unit to the suspension bolt positions.

- Install the inspection opening on the control box side where maintenance and inspection of the control box are easy. Install the inspection opening also in the lower part of the unit.

## ■ Make sure the range of the unit's external static pressure is not exceeded.

(See the technical documentation for the range of the external static pressure setting.)

## ■ Open the installation hole. (Pre-set ceilings)

- Once the installation hole is opened in the ceiling where the unit is to be installed, pass refrigerant piping, drain piping, transmission wiring, and remote controller wiring (unnecessary if using a wireless remote controller) to the unit's piping and wiring holes. See "REFRIGERANT PIPING WORK", "DRAIN PIPING WORK", and "WIRING".
- After opening the ceiling hole, make sure ceiling is level if needed. It might be necessary to reinforce the ceiling frame to prevent shaking. Consult an architect or carpenter for details.

## ■ Install the suspension bolts.

(Use W3/8 to M10 suspension bolts.)

Use a hole-in-anchor, sunken insert, sunken anchor for existing ceilings, and a sunken insert, sunken anchor or other part to be procured in the field to reinforce the ceiling to bearing the weight of the unit. (Refer to Fig.)

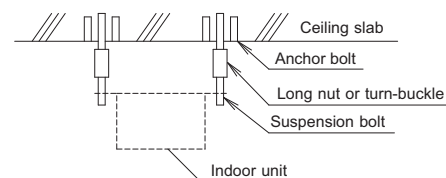
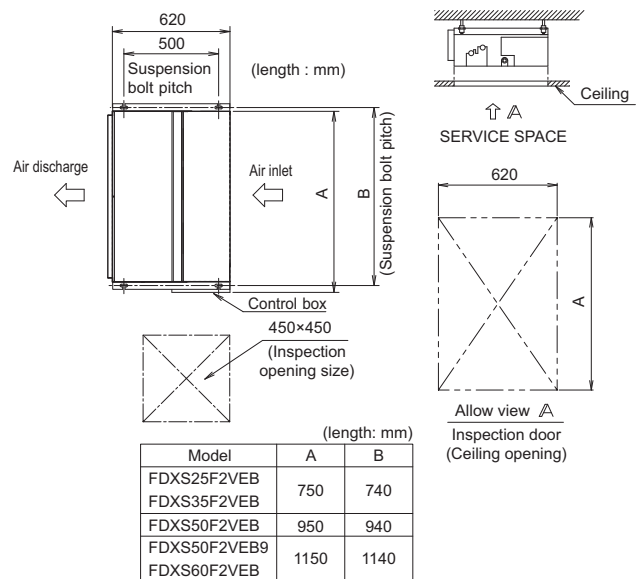

Note: All the above parts are field supplied.

■ **Mount chamber lid and air filter (accessory).**

In case of bottom suction.

- (1) Remove the chamber lid. (7 locations)
- (2) Reattach the removed chamber lid in the orientation shown in Fig.(7 locations)
- (3) Attach sealing pad as shown in the figure below. (Stored in outlet vent) (only for 50-60 type)

(In order to take in the air inside the ceiling, and when not taking in air from outdoor air, it is not necessary to stick.)

- Attach the sealing pad (accessory) to the plate metal lid which are not covered by anti-sweat material.
- Make sure there are no gaps between the different pieces of sealing pad.

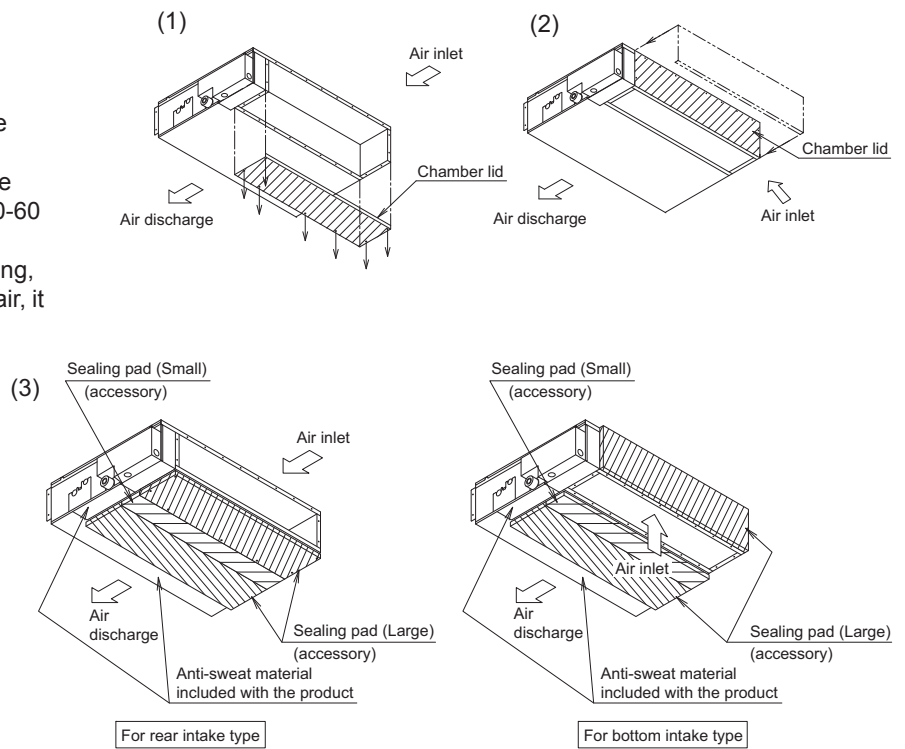

- (4) Attach the hanger (right) insulation to the right hanger. (Stored in outlet vent) (See the below figure for the sticking base line.)

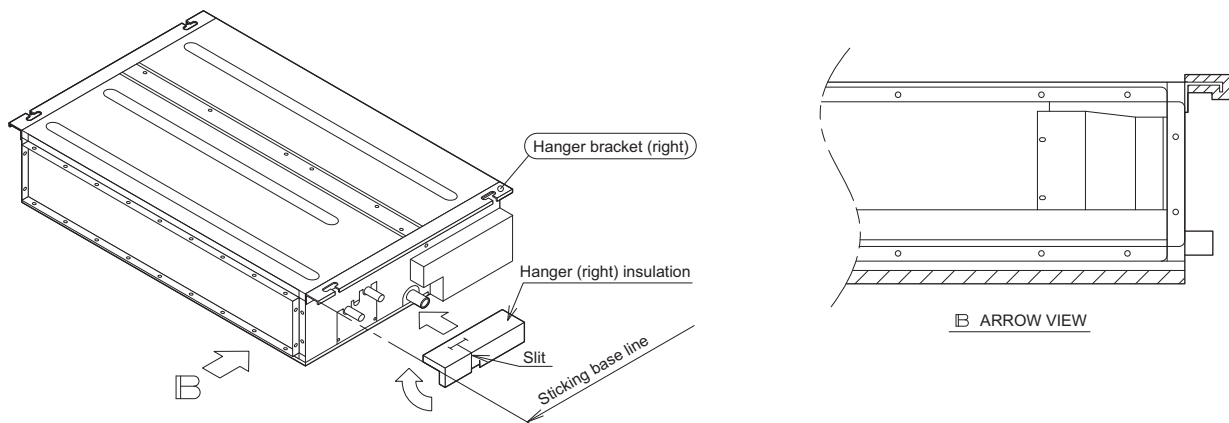

- (5) Attach the air filter (accessory) in the manner shown in the diagram.

In case of bottom side

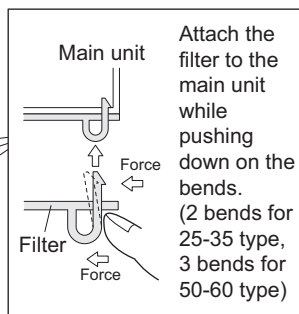
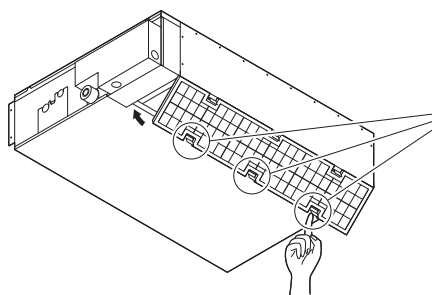

In case of back side

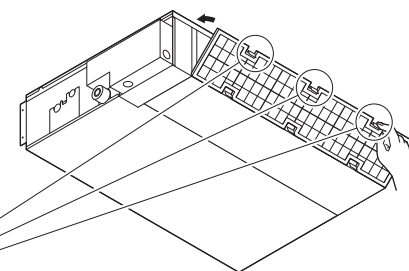

# INDOOR UNIT INSTALLATION

《 As for the parts to be used for installation work, be sure to use the provided accessories and specified parts designated by our company. 》

## ■ Install the indoor unit temporarily.

- Attach the hanger bracket to the suspension bolt. Be sure to fix it securely by using a nut and washer from the upper and lower sides of the hanger bracket. (Refer to Fig.)

### [ PRECAUTION ]

Since the unit uses a plastic drain pan, prevent welding spatter and other foreign substances from entering the outlet hole during installation.

### [ Securing the hanger bracket ]

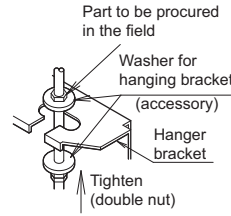

### [ How to secure washers ]

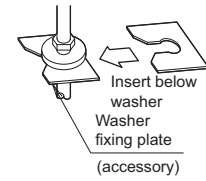

## ■ Adjust the height of the unit.

## ■ Check the unit is horizontally level.

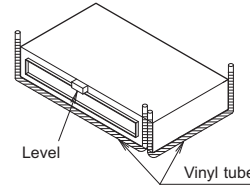

## ⚠ Caution

Make sure the unit is installed level using a level or a plastic tube filled with water. In using a plastic tube instead of a level, adjust the top surface of the unit to the surface of the water at both ends of the plastic tube and adjust the unit horizontally. (One thing to watch out for in particular is if it is installed so that the slope is not in the direction of the drain piping, as this might cause leaking.)

## ■ Tighten the upper nut.

## ■ Mounting the remote controller.

Refer to the "installation manual of the remote controller" supplied with remote controller.

For heat pump: If your feet feel cold when using the heating function, it is recommended that the air discharge grille shown at below be attached.

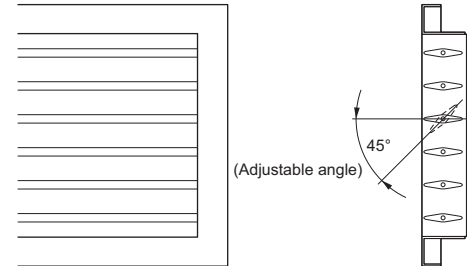



# OUTDOOR UNIT INSTALLATION

Install as described in the installation manual supplied with the outdoor unit.

## REFRIGERANT PIPING WORK

See the installation manual supplied with the outdoor unit.

### 1. FLARING THE PIPE END

- 1) Cut the pipe end with a pipe cutter.
- 2) Remove burrs with the cut surface facing downward so that the chips do not enter the pipe.
- 3) Put the flare nut on the pipe.
- 4) Flare the pipe.
- 5) Check that the flaring is properly made.

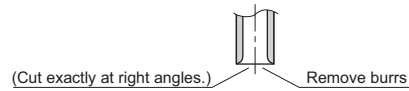

**Flaring**

Set exactly at the position shown below.

	Flare tool for R410A		Conventional flare tool	
	Clutch-type	Clutch-type (Ridgid-type)	Wing-nut type (Imperial-type)	
A	0-0.5mm	1.0-1.5mm	1.5-2.0mm	

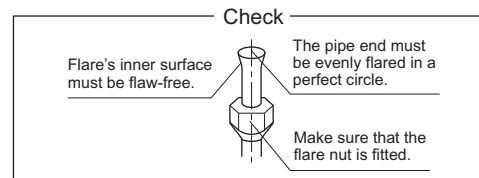

### Warning

- Do not use mineral oil on flared part.
- Prevent mineral oil from getting into the system as this would reduce the lifetime of the units.
- Never use piping which has been used for previous installations. Only use parts which are delivered with the unit.
- Do never install a dryer to this R410A unit in order to guarantee its lifetime.
- The drying material may dissolve and damage the system.
- Incomplete flaring may cause refrigerant gas leakage.

### 2. REFRIGERANT PIPING

- 1) To prevent gas leakage, apply refrigeration machine oil on both inner and outer surfaces of the flare. (Use refrigeration oil for R410A)
- 2) Align the centres of both flares and tighten the flare nuts 3 or 4 turns by hand. Then tighten them fully with the torque wrenches.
  - Use torque wrenches when tightening the flare nuts to prevent damage to the flare nuts and escaping gas.

Flare nut tightening torque		
Gas side		Liquid side
Ø9.5	Ø12.7	Ø6.4
33-39N·m	50-60N·m	15-17N·m

### Caution

- Overtightening may damage the flare and cause leaks.

# REFRIGERANT PIPING WORK

3) After the work is finished, make sure to check that there is no gas leak.

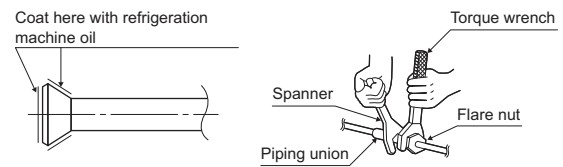

4) After checking for gas leaks, be sure to insulate the pipe connections.

- Insulate using the insulation for fitting included with the liquid and gas pipes. Besides, make sure the insulation for fitting on the liquid and gas piping has its seams facing up. (Tighten both edges with clamp.)
- For the gas piping, wrap the medium sealing pad over the insulation for fitting (flare nut part).

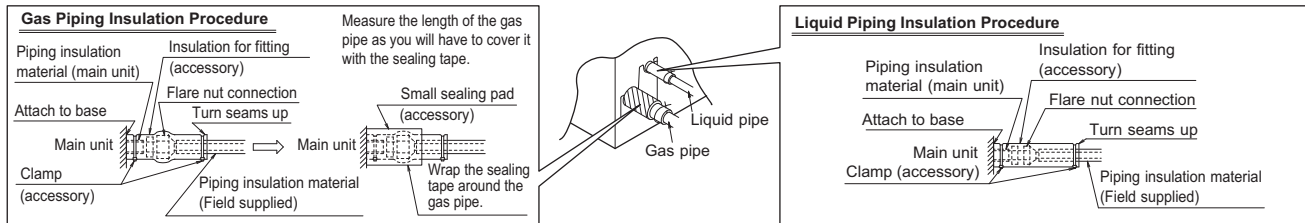

## Caution

Be sure to insulate any field piping all the way to the piping connection inside the unit. Any exposed piping may cause condensation or burns if touched.

## Cautions on Pipe Handling

- Protect the open end of the pipe against dust and moisture. (Tighten both edges with clamp.)
- All pipe bends should be as gentle as possible. Use a pipe bender for bending. (Bending radius should be 30 to 40mm or larger.)

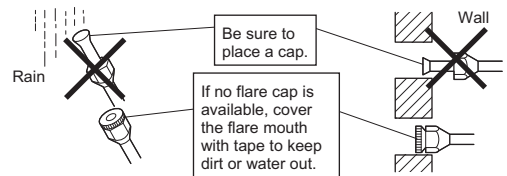

## Selection of Copper and Heat Insulation materials

When using commercial copper pipes and fittings, observe the following:

- Insulation material: Polyethylene foam  
Heat transfer rate: 0.041 to 0.052W/mK (0.035 to 0.045kcal/mh°C)  
Refrigerant gas pipe's surface temperature reaches 110°C max.  
Choose heat insulation materials that will withstand this temperature.
- Be sure to insulate both the gas and liquid piping and to provide insulation dimensions as below.

Gas side		Liquid side	Gas pipe thermal insulation		Liquid pipe thermal insulation
25/35 class	50/60 class		25/35 class	50/60 class	
O.D. 9.5mm	O.D. 12.7mm	O.D. 6.4mm	I.D. 12-15mm	I.D. 14-16mm	I.D. 8-10mm
Thickness 0.8mm			Thickness 10mm Min.		

Also, when subject to high humidity, heat insulation of the refrigerant piping (the unit piping and branch piping) must be further reinforced. Reinforce the insulation when installing the unit near bathrooms, kitchens, and other similar locations.

Refer to the following:

- 30°C, more than 75% RH: 20mm Min. in thickness

If the insulation is not sufficient, condensation may form on the surface of the insulation.

- Use separate thermal insulation pipes for gas and liquid refrigerant pipes.

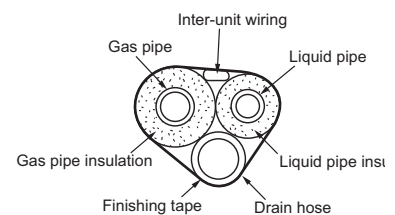

# DRAIN PIPING WORK

## ⚠ Caution

Make sure all water is out before making the duct connection.

### ■ Install the drain piping.

- Make sure the drain works properly.
- The diameter of the drain pipe should be greater than or equal to the diameter of the connecting pipe (vinyl tube; pipe size: 20mm; outer dimension: 26mm).
- Keep the drain pipe short and sloping downwards at a gradient of at least 1/100 to prevent air pockets from forming.

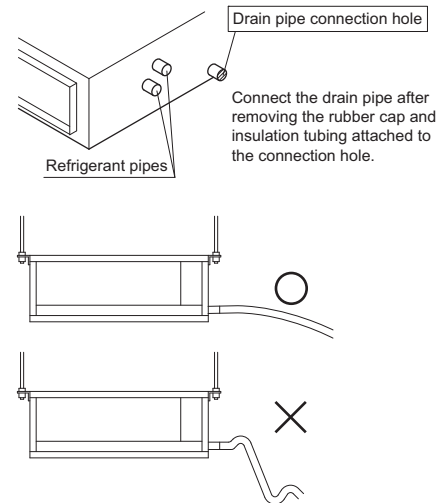

## ⚠ Caution

Water accumulating in the drain piping can cause the drain to clog.

- To keep the drain tube from sagging, space hanging wires every 1 to 1.5m.
- Use the drain hose and the metal clamp. Insert the drain hose fully into the drain socket and firmly tighten the metal clamp with the upper part of the tape on the hose end. Tighten the metal clamp until the screw head is less than 4mm from the hose.
- The two areas below should be insulated because condensation may form there causing water to leak.
  - Drain piping passing indoors
  - Drain sockets

Referring the figure below, insulate the metal clamp and drain hose using the included large sealing pad.

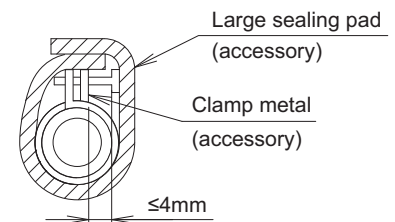
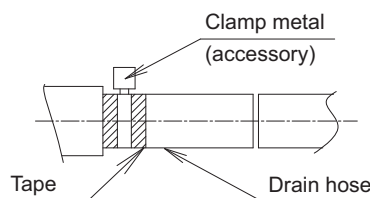

### < PRECAUTIONS >

Drain piping connections

- Do not connect the drain piping directly to sewage pipes that smell of ammonia. The ammonia in the sewage might enter the indoor unit through the drain pipes and corrode the heat exchanger.
- Do not twist or bend the drain hose, so that excessive force is not applied to it. (This type of treatment may cause leaking.)

### ■ After piping work is finished, check drainage flows smoothly.

- Gradually insert approximately 1L of water into the drain pan to check drainage in the manner described below.
  - Gradually pour approximately 1L of water from the outlet hole into the drain pan to check drainage.
  - Check the drainage.

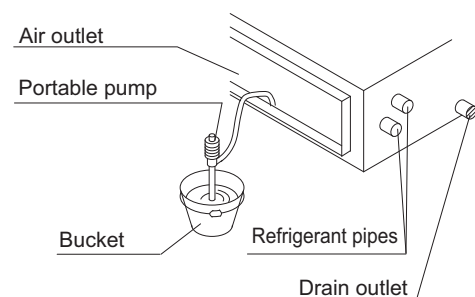

# INSTALLING THE DUCT

Connect the duct supplied in the field.

## Air inlet side

- Attach the duct and intake-side flange (field supply).
- Connect the flange to the main unit with accessory screws (in 16, 20 or 24 positions).
- Wrap the intake-side flange and duct connection area with aluminum tape or something similar to prevent air escaping.

## ⚠ Caution

When attaching a duct to the intake side, be sure also to attach an air filter inside the air passage on the intake side. (Use an air filter whose dust collecting efficiency is at least 50% in a gravimetric technique.)

## Outlet side

- Connect the duct according to the inside of the outlet-side flange.
- Wrap the outlet-side flange and the duct connection area with aluminum tape or something similar to prevent air escaping.

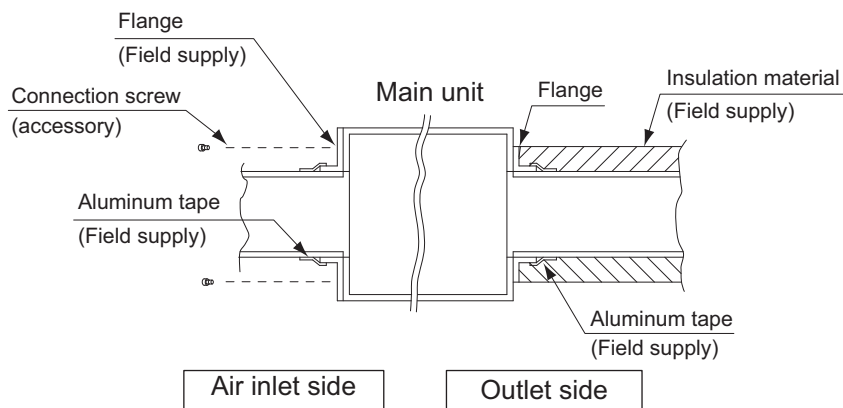

## ⚠ Caution

- Be sure to insulate the duct to prevent condensation from forming. (Material: glass wool or polyethylene foam, 25mm thick)
- Use electric insulation between the duct and the wall when using metal ducts to pass metal laths of the net or fence shape or metal plating into wooden buildings.

# WIRING

See the installation manual supplied with the outdoor unit.

## ■ HOW TO CONNECT WIRINGS.

- Wire only after removing the control box lid as shown in the Fig.

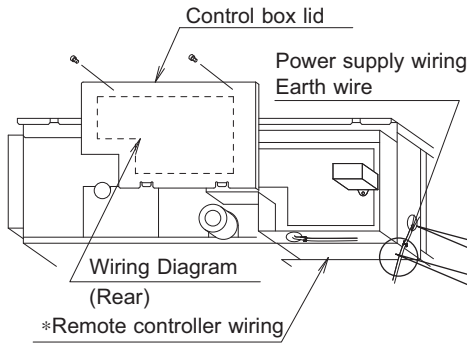

- ⚠ • Make sure to let a wire go through a wire penetration area.
  - After wiring, seal the wire and wire penetration area to prevent moisture and small creatures from the outside.
  - Wrap the strong and weak electric lines with the sealing material as shown in the figure below.
- (Otherwise, moisture or small creatures such as insects from the outside may cause short-circuit inside the control box.)  
Attach securely so that there are no gaps.

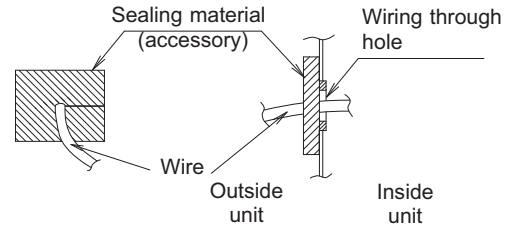

## ⚠ Caution

- When clamping the wiring, use the included clamping material as shown in the Fig. to prevent outside pressure being exerted on the wiring connections and clamp firmly.
- When doing the wiring, make sure the wiring is neat and does not cause the control box lid to stick up, then close the cover firmly. When attaching the control box lid, make sure you do not pinch any wires.
- Outside the machine, separate the weak wiring (remote controller wiring) and strong wiring (earth wire and power supply wiring) at least 50mm so that they do not pass through the same place together. Proximity may cause electrical interference, malfunctions, and breakage.

## [ PRECAUTION ]

- See also the "Electrical Wiring Diagram Nameplate" when wiring the unit for electrical power.

## [ Connecting electrical wiring ]

### • Power supply wiring and Earth wire

Remove the control box lid.

Next, pull the wires into the unit through the wiring through hole and connect to the power wiring terminal block (4P).

Be sure to put the part of the sheathed vinyl into the control box.

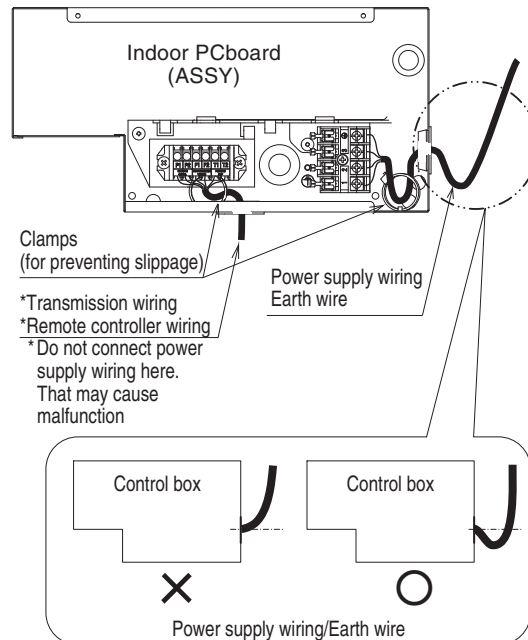

## ⚠ Warning

Do not use tapped wires, stand wires, extensioncords, or starburst connections, as they may cause overheating, electrical shock, or fire.

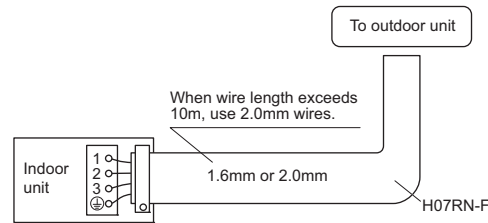

# TRIAL OPERATION AND TESTING

## Trial operation and testing

- (1) Measure the supply voltage and make sure that it falls in the specified range.
- (2) Trial operation should be carried out in either cooling or heating mode.

### Trial operation from remote controller

- (1) Press ON/OFF button to turn on the system.
- (2) Simultaneously press center of TEMP button and MODE button.
- (3) Press MODE button twice.  
("T" will appear on the display to indicate that Trial Operation mode is selected.)
- (4) Trial run mode terminates in approx. 30 minutes and switches into normal mode. To quit a trial operation, press ON/OFF button.

### ■ For Heat pump.

In cooling mode, select the lowest programmable temperature; in heating mode, select the highest programmable temperature.

- Trial operation may be disabled in either mode depending on the room temperature.
- After trial operation is complete, set the temperature to a normal level (26°C to 28°C in cooling mode, 20°C to 24°C in heating mode).
- For protection, the system disables restart operation for 3 minutes after it is turned off.

- (3) Carry out the test operation in accordance with the Operation Manual to ensure that all functions and parts, are working properly.

\* The air conditioner requires a small amount of power in its standby mode. If the system is not to be used for some time after installation, shut off the circuit breaker to eliminate unnecessary power consumption.

\* If the circuit breaker trips to shut off the power to the air conditioner, the system will restore the original operation mode when the circuit breaker is turned on again.

## Test items

Test items	Symptom (diagnostic display on RC)	Check
Indoor and outdoor units are installed properly on solid bases.	Fall, vibration, noise	
No refrigerant gas leaks.	Incomplete cooling/heating function	
Refrigerant gas and liquid pipes and indoor drain hose extension are thermally insulated.	Water leakage	
Draining line is properly installed.	Water leakage	
System is properly earthed.	Electrical leakage	
The specified wires are used for interconnecting wire connections.	Inoperative or burn damage	
Indoor or outdoor unit's air inlet or discharge has clear path of air. Shut-off valves are opened.	Incomplete cooling/heating function	
Indoor unit properly receives remote controller commands.	Inoperative	

# WIRING DIAGRAM

	: FIELD WIRING
	: CONNECTOR
	: WIRE CLAMP
	: PROTECTIVE EARTH (SCREW)
L	: LIVE
N	: NEUTRAL

BLK	: BLACK	PRP	: PURPLE
BLU	: BLUE	RED	: RED
BRN	: BROWN	WHT	: WHITE
GRY	: GREY	YLW	: YELLOW
ORG	: ORANGE	GRN	: GREEN
PNK	: PINK		

## INDOOR UNIT

A1P	.....	PRINTED CIRCUIT BOARD
C105	.....	CAPACITOR
PS	.....	POWER SUPPLY CIRCUIT
RC	.....	RECEIVING CIRCUIT
TC	.....	TRANSMISSION CIRCUIT
HAP	.....	LIGHT EMITTING DIODE (SERVICE MONITORING –GREEN)
M1F	.....	MOTOR (FAN)
M1P	.....	MOTOR (DRAIN PUMP)
Q1DI	.....	EARTH LEAK DETECTOR
R1T	.....	THERMISTOR (AIR)
R2T, R3T	.....	THERMISTOR (COIL)
S1L	.....	FLOAT SWITCH
SS1	.....	SELECTOR SWITCH (EMERGENCY)
V1R	.....	DIODE BRIDGE
X1M	.....	TERMINAL BLOCK (CONTROL)
X2M	.....	TERMINAL BLOCK (POWER SUPPLY)
Z1C	.....	FERRITE CORE (NOISE FILTER)
Z1F	.....	NOISE FILTER
F3U	.....	FUSE((F),5A,250V)

## RECEIVER/DISPLAY UNIT

A2P	.....	PRINTED CIRCUIT BOARD
A3P	.....	PRINTED CIRCUIT BOARD
BS1	.....	PUSH BUTTON (ON/OFF)
H1P	.....	LIGHT EMITTING DIODE (ON-RED)
H2P	.....	LIGHT EMITTING DIODE (FILTER DING-RED)
H3P	.....	LIGHT EMITTING DIODE (TIMER-GREEN)
H4P	.....	LIGHT EMITTING DIODE (DEFROST-ORANGE)
SS1	.....	SELECTOR SWITCH (MAIN/SUB)
SS2	.....	SELECTOR SWITCH (WIRELESS ADDRESS SET)

## ADAPTOR FOR WIRING

KHuR	.....	MAGNETIC RELAY
KFR	.....	MAGNETIC RELAY
KCR	.....	MAGNETIC RELAY
F1U	.....	FUSE((B),5A,250V)
F2U	.....	FUSE((B),5A,250V)

## CONNECTOR FOR OPTIONAL PARTS

X24A	.....	CONNECTOR (WIRELESSREMOTE CONTROLLER)
X33A	.....	CONNECTOR (ADAPTOR FOR WIRING)
X35A	.....	CONNECTOR (POWER SUPPLY CONNECTOR)

## WIRED REMOTE CONTROLLER

R1T	.....	THERMISTOR (AIR)
SS1	.....	SELECTOR SWITCH (MAIN/SUB)

WIRED REMOTE CONTROLLER	:	Wired remote controller
(OPTIONAL ACCESSORY)	:	(Optional accessory)
SWITCH BOX (INDOOR)	:	Switch box (indoor)
TRANSMISSION WIRING	:	Transmission wiring
CENTRAL REMOTE CONTROLLER	:	Central remote controller
INPUT FROM OUTSIDE	:	Input from outside

- 
- NOTE**
1. USE COPPER CONDUCTORS ONLY.
  2. WHEN USING THE CENTRAL REMOTE CONTROLLER, SEE MANUAL FOR CONNECTION TO THE UNIT.
  3. WHEN CONNECTING THE INPUT WIRES FROM OUTSIDE, FORCED "OFF" OR "ON/OFF" CONTROL OPERATION CAN BE SELECTED BY THE REMOTE CONTROLLER. SEE INSTALLATION MANUAL FOR MORE DETAILS.
  4. REMOTE CONTROLLER MODEL VARIES ACCORDING TO THE COMBINATION SYSTEM, CONFIRM ENGINEERING DATA AND CATALOGS, ETC. BEFORE CONNECTING.
-