



TIPO	MODELO DE ARREFECIMENTO	
MODELO	UNIDADE INTERNA	ASY9FSBCW
	UNIDADE EXTERNA	AOY9FSBC
FICHA TECNICA		
ALIMENTAÇÃO	230 V-50 Hz	
ARREFECIMENTO		
POTÊNCIA	2,75 kW	
POTÊNCIA CONSUMIDA	1,05 kW	
CORRENTE CONSUMIDA	4,7 A	
COEFICIENTE DE EFICIÊNCIA ENERGÉTICA	2,62	
CORRENTE MÁX.		
Arrefecimento	5,8 A	
PRESSÃO MÁXIMA		
ASPIRAÇÃO	1,160 kPa	
COMPRESSÃO	4,120 kPa	
REFRIGERANTE	R410A 590 g	
DIMENSÕES E PESO (LÍQUIDO)		
UNIDADE INTERNA		
ALTURA/COMPRIMENTO/PROFUNDIDADE	257/808/187 mm	
PESO	8,0 kg (NET)	
UNIDADE EXTERNA		
ALTURA/COMPRIMENTO/PROFUNDIDADE	535/695/250 mm	
PESO	30 kg (NET)	

TIPO	MODELO DE ARREFECIMENTO	
MODELO	UNIDADE INTERNA	ASY12FSBCW
	UNIDADE EXTERNA	AOY12FSBC
FICHA TECNICA		
ALIMENTAÇÃO	230 V-50 Hz	
ARREFECIMENTO		
POTÊNCIA	3,4 kW	
POTÊNCIA CONSUMIDA	1,33 kW	
CORRENTE CONSUMIDA	6,2 A	
COEFICIENTE DE EFICIÊNCIA ENERGÉTICA	2,56	
CORRENTE MÁX.		
Arrefecimento	7,3 A	
PRESSÃO MÁXIMA		
ASPIRAÇÃO	1,160 kPa	
COMPRESSÃO	4,120 kPa	
REFRIGERANTE	R410A 720 g	
DIMENSÕES E PESO (LÍQUIDO)		
UNIDADE INTERNA		
ALTURA/COMPRIMENTO/PROFUNDIDADE	257/808/187 mm	
PESO	8,0 kg (NET)	
UNIDADE EXTERNA		
ALTURA/COMPRIMENTO/PROFUNDIDADE	535/695/250 mm	
PESO	32 kg (NET)	

FUJITSU

OPERATING MANUAL
 BEDIENUNGSANLEITUNG
 MODE D'EMPLOI
 MANUAL DE FUNCIONAMIENTO
 MANUALE DI ISTRUZIONI
 ΕΓΧΕΙΡΙΔΙΟ ΛΕΙΤΟΥΡΓΙΑΣ
 MANUAL DE INSTRUÇÕES

COOLING MODEL
 ROOM AIR CONDITIONER
 WALL MOUNTED TYPE

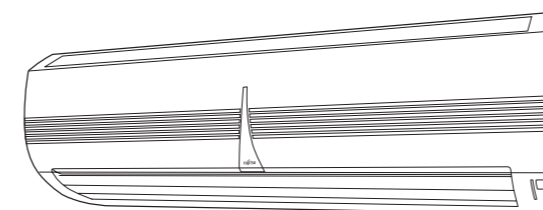

Indoor Unit
ASY9FSBCW
ASY12FSBCW
 Outdoor Unit
AOY9FSBC
AOY12FSBC

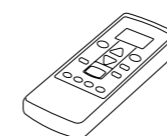

English

Deutsch

Français

Español

Italiano

Ελληνικά

Português

FUJITSU

FUJITSU GENERAL LIMITED
 1116, Suenaga, Takatsu-ku, Kawasaki 213-8502, Japan

KEEP THIS OPERATION MANUAL
 FOR FUTURE REFERENCE

FUJITSU GENERAL LIMITED

P/N9312355013-02

Fig. 1

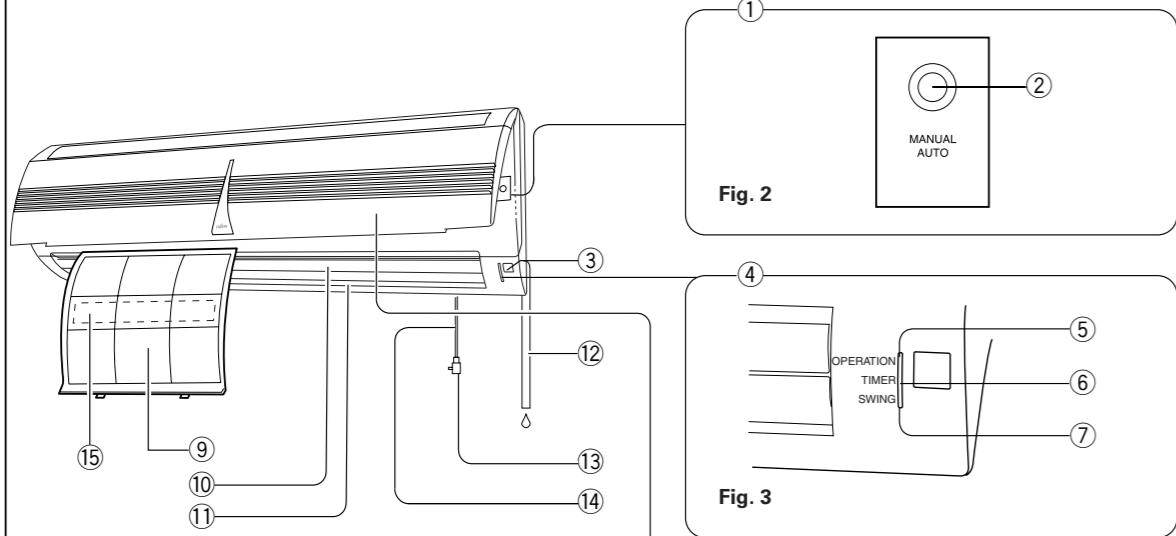
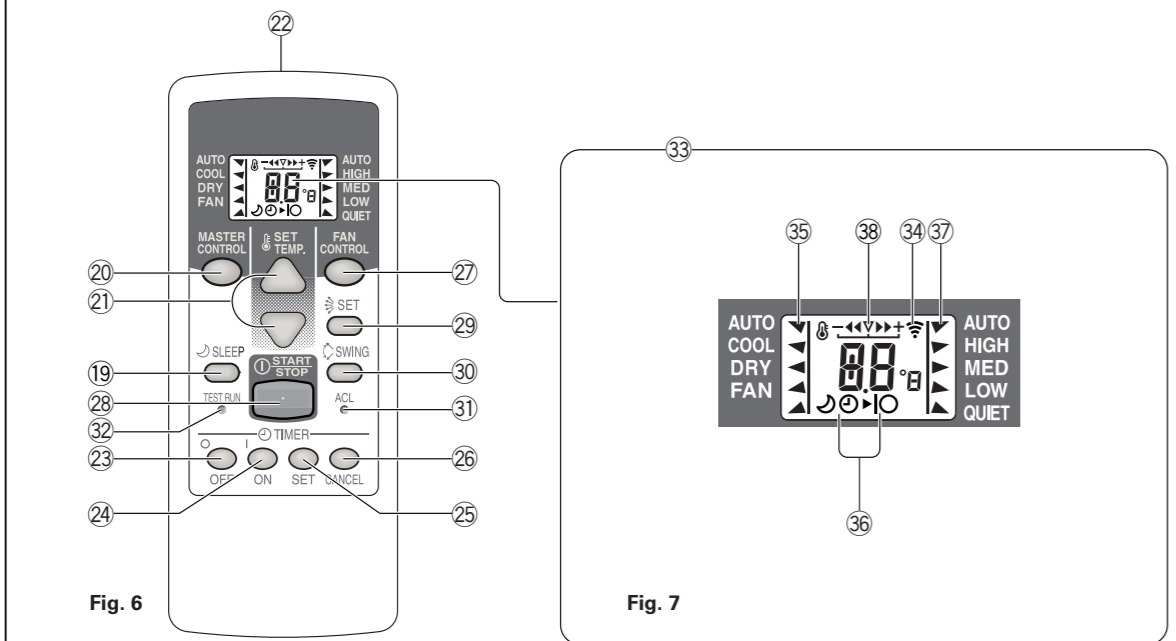
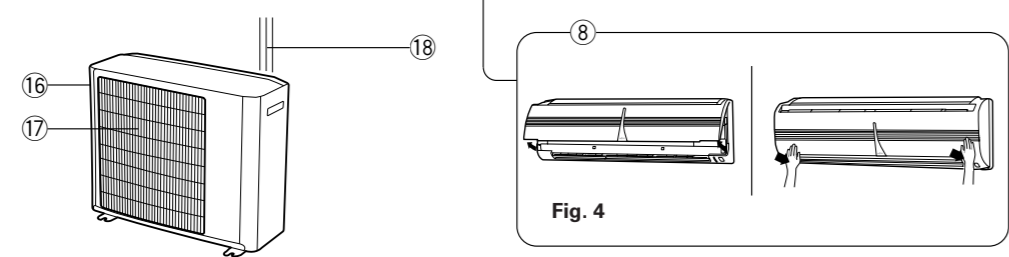

Fig. 5



This figure shows the control display when all indicator lamps are on. It may differ from the actual display.

CONTENTS

SAFETY PRECAUTIONS	En-1	ADJUSTING THE DIRECTION OF	
FEATURES AND FUNCTIONS	En-2	AIR CIRCULATION	En-9
NAME OF PARTS	En-3	SWING OPERATION	En-10
PREPARATION	En-4	MANUAL AUTO OPERATION	En-10
OPERATION	En-5	CLEANING AND CARE	En-11
TIMER OPERATION	En-7	TROUBLESHOOTING	En-12
SLEEP TIMER OPERATION	En-8	OPERATING TIPS	En-13

SAFETY PRECAUTIONS



- Do not attempt to install this air conditioner by yourself.
- This unit contains no user-serviceable parts. Always consult authorized service personnel for repairs.
- When moving, consult authorized service personnel for disconnection and installation of the unit.
- Do not become excessively chilled by staying for lengthy periods in the direct cooling airflow.
- Do not insert fingers or objects into the outlet port or intake grilles.
- Do not start and stop air conditioner operation by disconnecting the power supply cord and so on.
- Take care not to damage the power supply cord.
- In the event of a malfunction (burning smell, etc.), immediately stop operation, disconnect the power supply plug, and consult authorized service personnel.
- If the power supply cord of this appliance is damaged, it should only be replaced by the authorized service personal, since special purpose tools and specified cord are required.



- Provide occasional ventilation during use.
- Do not direct air flow at fireplaces or heating apparatus.
- Do not climb on, or place objects on, the air conditioner.
- Do not hang objects from the indoor unit.
- Do not set flower vases or water containers on top of air conditioners.
- Do not expose the air conditioner directly to water.
- Do not operate the air conditioner with wet hands.
- Do not pull power supply cord.
- Turn off power source when not using the unit for extended periods.
- Check the condition of the installation stand for damage.
- Do not place animals or plants in the direct path of the air flow.
- Do not drink the water drained from the air conditioner.
- Do not use in applications involving the storage of foods, plants or animals, precision equipment, or art works.
- Do not apply any heavy pressure to radiator fins.
- Operate only with air filters installed.
- Do not block or cover the intake grille and outlet port.
- Ensure that any electronic equipment is at least one metre away from either the indoor or outdoor units.
- Avoid installing the air conditioner near a fireplace or other heating apparatus.
- When installing the indoor and outdoor unit, take precautions to prevent access to infants.
- Do not use inflammable gases near the air conditioner.

MODEL MODELL MODELE MODELO MODELLO MONTEAO	INDOOR UNIT INNENGERÄT UNITÉ INTÉRIEURE	UNIDAD INTERIOR APPARECCHIO INTERNO ΕΣΩΤΕΡΙΚΗ ΜΟΝΑΔΑ	ASY9FSBCW
	OUTDOOR UNIT AUSSENGERÄT UNITÉ EXTERIEURE	UNIDAD EXTERIOR APPARECCHIO ESTERNO ΕΣΩΤΕΡΙΚΗ ΜΟΝΑΔΑ	AOY9FSBC

ESPECIFICACIONES		PRESIÓN MÁX.	
ALIMENTACIÓN	230 V~50 Hz	SUCCION	1.160 kPa
REFRIGERACIÓN		DESCARGA	4.120 kPa
CAPACIDAD	2,75 kW	REFRIGERANTE	R410A 590 g
ENTRADA DE ALIMENTACIÓN	1,06kW	DIMENSIONES Y PESO	
CORRIENTE	4,7 A	UNIDAD INTERIOR	
RAZÓN DE EFICIENCIA DE ENERGÍA	2,62	Altura/anchura/profundidad	257/808/187 mm
CORRIENTE MÁX		Peso	8,0 kg (NETO)
Refrigeración	5,8 A	UNIDAD EXTERIOR	Altura/anchura/profundidad
			535/695/250 mm
			Peso
			30 kg (NETO)

DATI TECNICI		PRESSIONE MASSIMA	
ALIMENTAZIONE	230 V~50 Hz	ASPIRAZIONE	1.160 kPa
RAFFREDDAMENTO		EMISSIONE	4.120 kPa
CAPACITÀ	2,75 kW	REFRIGERANTE	R410A 590 g
CONSUMO	1,06kW	DIMENSIONI E PESO	
CORRIENTE	4,7 A	APPARECCHIO INTERNO	
RAPPORTO ENERGETICO DI EFFICIENZA	2,62	Altezza x Larghezza x Profondità	257/808/187 mm
CORRENTE MASSIMA		Peso	8,0 kg (netti)
Raffreddamento	5,8 A	APPARECCHIO ESTERNO	Altezza x Larghezza x Profondità
			535/695/250 mm
			Peso
			30 kg (netti)

ΧΑΡΑΚΤΗΡΙΣΤΙΚΑ		ΜΕΓΙΣΤΗ ΠΙΕΣΗ	
ΤΡΟΦΟΔΟΣΙΑ	230 V~50 Hz	ΑΝΑΡΡΟΦΗΣΗ	1.160 kPa
ΨΥΞΗ		ΕΚΤΟΝΩΣΗ	4.120 kPa
ΔΥΝΑΤΟΤΗΤΑ	2,75 kW	ΨΥΚΤΙΚΟ	R410A 590 g
ΙΣΧΥΣ ΕΙΣΟΔΟΥ	1,06kW	ΔΙΑΣΤΑΣΕΙΣ ΚΑΙ ΒΑΡΟΣ	
ΡΕΥΜΑ	4,7 A	ΕΣΩΤΕΡΙΚΗ ΜΟΝΑΔΑ	
ΣΥΝΤΕΛΕΣΤΗΣ ΑΠΟΔΟΣΕΩΣ ΕΝΕΡΓΕΙΑΣ	2,62	ΥΨΟΣ/ΠΛΑΤΟΣ/ΒΑΘΟΣ	257/808/187 mm
Μέγιστη Χωρητικότητα Ψύξης	5,8 A	ΒΑΡΟΣ	8,0 kg (ΚΑΘΑΡΟ)
		ΕΣΩΤΕΡΙΚΗ ΜΟΝΑΔΑ	ΥΨΟΣ/ΠΛΑΤΟΣ/ΒΑΘΟΣ
			535/695/250 mm
			ΒΑΡΟΣ
			30 kg (ΚΑΘΑΡΟ)

MODEL MODELL MODELE MODELO MODELLO MONTEAO	INDOOR UNIT INNENGERÄT UNITÉ INTÉRIEURE	UNIDAD INTERIOR APPARECCHIO INTERNO ΕΣΩΤΕΡΙΚΗ ΜΟΝΑΔΑ	ASY12FSBCW
	OUTDOOR UNIT AUSSENGERÄT UNITÉ EXTERIEURE	UNIDAD EXTERIOR APPARECCHIO ESTERNO ΕΣΩΤΕΡΙΚΗ ΜΟΝΑΔΑ	AOY12FSBC

ESPECIFICACIONES		PRESIÓN MÁX.	
ALIMENTACIÓN	230 V~50 Hz	SUCCION	1.160 kPa
REFRIGERACIÓN		DESCARGA	4.120 kPa
CAPACIDAD	3,4 kW	REFRIGERANTE	R410A 720 g
ENTRADA DE ALIMENTACIÓN	1,33 kW	DIMENSIONES Y PESO	
CORRIENTE	6,2 A	UNIDAD INTERIOR	
RAZÓN DE EFICIENCIA DE ENERGÍA	2,56	Altura/Anchura/Profundidad	257/808/187 mm
CORRIENTE MÁX		Peso	8,0 kg (NETO)
Refrigeración	7,3 A	UNIDAD EXTERIOR	Altura/Anchura/Profundidad
			535/695/250 mm
			Peso
			32 kg

DATI TECNICI		PRESSIONE MASSIMA	
ALIMENTAZIONE	230 V~50 Hz	ASPIRAZIONE	1.160 kPa
RAFFREDDAMENTO		EMISSIONE	4.120 kPa
CAPACITÀ	3,4 kW	REFRIGERANTE	R410A 720 g
CONSUMO	1,33 kW	DIMENSIONI E PESO	
CORRIENTE	6,2 A	APPARECCHIO INTERNO	
RAPPORTO ENERGETICO DI EFFICIENZA	2,56	Altezza x Larghezza x Profondità	257/808/187 mm
CORRENTE MASSIMA		Peso	8,0 kg (netti)
Raffreddamento	7,3 A	APPARECCHIO ESTERNO	Altezza x Larghezza x Profondità
			535/695/250 mm
			Peso
			32 kg (netti)

ΧΑΡΑΚΤΗΡΙΣΤΙΚΑ		ΜΕΓΙΣΤΗ ΠΙΕΣΗ	
ΤΡΟΦΟΔΟΣΙΑ	230 V~50 Hz	ΑΝΑΡΡΟΦΗΣΗ	1.160 kPa
ΨΥΞΗ		ΕΚΤΟΝΩΣΗ	4.120 kPa
ΔΥΝΑΤΟΤΗΤΑ	3,4 kW	ΨΥΚΤΙΚΟ	R410A 720 g
ΙΣΧΥΣ ΕΙΣΟΔΟΥ	1,33 kW	ΔΙΑΣΤΑΣΕΙΣ ΚΑΙ ΒΑΡΟΣ	
ΡΕΥΜΑ	6,2 A	ΕΣΩΤΕΡΙΚΗ ΜΟΝΑΔΑ	
ΣΥΝΤΕΛΕΣΤΗΣ ΑΠΟΔΟΣΕΩΣ ΕΝΕΡΓΕΙΑΣ	2,56	ΥΨΟΣ/ΠΛΑΤΟΣ/ΒΑΘΟΣ	257/808/187 mm
Μέγιστη Χωρητικότητα Ψύξης	7,3 A	ΒΑΡΟΣ	8,0 kg (ΚΑΘΑΡΟ)
		ΕΣΩΤΕΡΙΚΗ ΜΟΝΑΔΑ	ΥΨΟΣ/ΠΛΑΤΟΣ/ΒΑΘΟΣ
			535/695/250 mm
			ΒΑΡΟΣ
			32 kg (ΚΑΘΑΡΟ)



FEATURES AND FUNCTIONS

AUTOMATIC OPERATION

Merely press the START/STOP button, and the unit will begin automatic operation in the Cooling or Dry mode as appropriate, in accordance with the thermostat setting and the actual temperature of the room.

SLEEP TIMER

When the SLEEP timer button is pressed during Cooling mode, the thermostat setting is gradually raised during the period of operation. When the set time is reached, the unit automatically turns off.

WIRELESS REMOTE CONTROLLER

The Wireless Remote Controller allows convenient control of air conditioner operation.

SWING OPERATION

The Air Flow Direction Louvers swings automatically up and down so that the air speeds to every nook and corner of your room.

REMOVABLE INTAKE GRILLE

The indoor unit's Intake Grille can be removed for easy cleaning and maintenance.

MILDEW-RESISTANT FILTER

The AIR FILTER has been treated to resist mildew growth, thus allowing cleaner use and easier care.

SUPER QUIET OPERATION

When the FAN CONTROL button is used to select QUIET, the unit begins super-quiet operation; the indoor unit's airflow is reduced to produce quieter operation.

AIR CLEANING FILTER (Optional)

The optional Air Cleaning Filter (Model APS-03B) uses an electrostatic principle to clean the air of fine particulate matter such as tobacco smoke and plant pollen.





NAME OF PARTS

Fig. 1 Indoor Unit

- ① Operating Control Panel (Fig. 2)
- ② MANUAL AUTO button
- ③ Remote Control Signal Receiver
- ④ Indicator Lamps (Fig. 3)
 - ⑤ OPERATION Indicator Lamp (red)
 - ⑥ TIMER Indicator Lamp (green)
 - If the TIMER indicator lamp flashes when the timer is operating, it indicates that a fault has occurred with the timer setting (See Page 13 Auto Restart).
 - ⑦ SWING Indicator Lamp (orange)
- ⑧ Intake Grille (Fig. 4)
- ⑨ Air Filter
- ⑩ Air Flow Direction Louver
- ⑪ Right-Left Louver
(behind Air Flow Direction Louver)
- ⑫ Drain Hose
- ⑬ Power Supply Plug
- ⑭ Power Supply Cord
- ⑮ Air Cleaning Filter (optional)

Fig. 5 Outdoor Unit

- ⑯ Intake Port
- ⑰ Outlet Port
- ⑱ Pipe Unit

Fig. 6 Remote Controller

- ⑲ SLEEP button
- ⑳ MASTER CONTROL button
- ㉑ SET TEMP. buttons (△ / ▽)
- ㉒ Signal Transmitter
- ㉓ OFF TIMER button
- ㉔ ON TIMER button
- ㉕ SET TIMER button
- ㉖ CANCEL TIMER button
- ㉗ FAN CONTROL button
- ㉘ START/STOP button
- ㉙ AIR FLOW DIRECTION button
- ㉚ SWING LOUVER button
- ㉛ ACL button
(located inside battery compartment)
- ㉜ TEST RUN button
 - This button is used when installing the conditioner, and should not be used under normal conditions, as it will cause the air conditioner's thermostat function to operate incorrectly.
 - If this button is pressed during normal operation, the unit will switch to test operation mode, and the Indoor Unit's OPERATION Indicator Lamp and TIMER Indicator Lamp will begin to flash simultaneously.
 - To stop the test operation mode, press the START/STOP button to stop the air conditioner.
- ㉝ Remote Controller Display (Fig. 7)
 - ㉞ Transmit Indicator
 - ㉟ Operating Mode Display
 - ㊱ Timer Mode Display
 - OFFTIMER Mark: ○
 - ONTIMER Mark: |
 - SLEEPTIMER Mark: ↻
 - ㊲ Fan Speed Display
 - ㊳ Temperature and time display
 - It displays the temperature setting. However, when making the Timer setting, it will display the Timer time. (The temperature setting will reappear after finishing the timer setting)

● Refer to the folded out page on the cover.

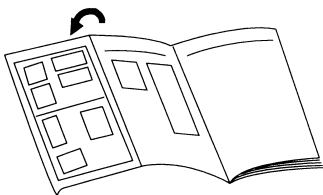

PREPARATION

Turn on the Power

- 1 Connect the Power Supply Plug (Fig. 1 ⑬) to an electrical outlet; in the case of a direct line connection, turn on the circuit breaker.**

Load Batteries (R03/LR03 × 2)

- 1 Press and slide the battery compartment lid on the reverse side to open it.**

Slide in the direction of the arrow while pressing the  mark.

- 2 Insert batteries.**

Be sure to align the battery polarities (\oplus/\ominus) correctly.

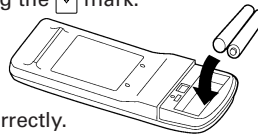

- 3 Close the battery compartment lid.**

CAUTION!

- Take care to prevent infants from accidentally swallowing batteries.
- When not using the Remote Controller for an extended period, remove the batteries to avoid possible leakage and damage to the unit.
- If leaking battery fluid comes in contact with your skin, eyes, or mouth, immediately wash with copious amounts of water, and consult your physician.
- Dead batteries should be removed immediately and disposed of properly, either in a battery collection receptacle or to the appropriate authority.
- Do not attempt to recharge dry batteries.

Never mix new and used batteries, or batteries of different types. Batteries should last about one year under normal use. If the Remote Controller's operating range becomes appreciably reduced, replace the batteries and press the ACL button with the tip of a ballpoint pen or other small object.

To Use the Remote Controller

- The Remote Controller must be pointed at signal receiver (Fig. 1 ⑬) to operate correctly.
- Operating Range: About 7 meters.
- When a signal is properly received by the air conditioner, a beeping sound will be heard.
- If no beep is heard, press the Remote Controller button again.

OPERATION

To Select Mode Operation

- 1 Press the START/STOP button (Fig.6 28).**
The indoor unit's OPERATION indicator lamp (red) (Fig. 3 5) will light.
The air conditioner will start operating.
- 2 Press the MASTER CONTROL button (Fig.6 20) to select the desired mode.**
Each time the button is pressed, the mode will change in the following order.

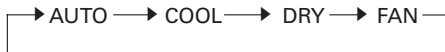

About three seconds later, the entire display will reappear.

To Set the Thermostat

Press the SET TEMP. buttons (Fig. 6 21).

- △ button: Press to raise the thermostat setting.
- ▽ button: Press to lower the thermostat setting.

●Thermostat setting range:

AUTO	Standard temperature setting ± 2 °C
Cooling/Dry	18-30 °C
FAN	17-30 °C

(During use of FAN mode, if the thermostat is set at 17 °C or lower, the display will show "--" and the fan will operate continuously, regardless of the room temperature.)

About three seconds later, the entire display will reappear.

The thermostat setting should be considered a standard value, and may differ somewhat from the actual room temperature.

To Set the Fan Speed

Press the FAN CONTROL button (Fig. 6 27).

Each time the button is pressed, the fan speed changes in the following order:

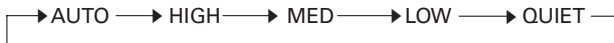

About three seconds later, the entire display will reappear.

When set to AUTO:

- Cooling** : As the room temperature approaches that of the thermostat setting, the fan speed becomes slower.
- Fan** : The fan will operate at the optimum speed in accordance with the room temperature in the vicinity of the indoor unit.

When set to QUIET:

SUPER QUIET operation begins. The indoor unit's airflow will be reduced for quieter operation.

- SUPER QUIET operation cannot be used during Dry mode. (The same is true when dry mode is selected during AUTO mode operation.)
- Cooling performance will be reduced somewhat during SUPER QUIET operation.

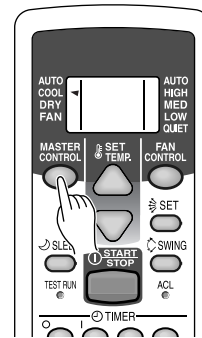

Example: When set to COOL.

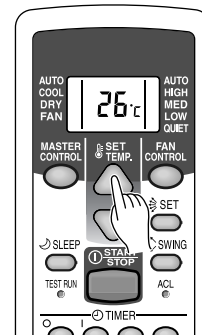

Example: When set to 26 °C.

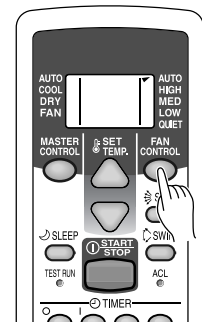

Example: When set to AUTO.



To Stop Operation

Press the **START/STOP** button.

The OPERATION indicator lamp (red) (Fig. 3 ⑤) will go out.

About Mode Operation

- AUTO:**
- Depending on the room temperature at the time operation begins, the operating mode will be switched automatically as shown in the accompanying table.
 - Also, depending on the operating mode, the room temperature setting will cause the "standard" temperature to be set as shown.

Actual Room Temperature	Operating Mode	Thermostat Setting (standard setting)
30 °C or above →	Cooling →	27 °C
27 °C to 30 °C →	Cooling →	26 °C
25 °C to 27 °C →	Dry →	24 °C
23 °C to 25 °C →	Dry →	22 °C
Below 23 °C →	Dry →	20 °C

The operating mode and standard thermostat settings are selected automatically when operation begins.

- When automatic operation is initiated, the fan will run at very low speed for about one minute while the unit detects and selects the proper operating mode.
- Once the operating mode has been set, the mode will not change even if the room temperature changes.
- If the START/STOP button is pressed to recommence operation within two hours after stopping automatic operation, the unit will begin operating from the same mode as before.

Cooling: ● Use to cool your room.

Dry:

- Use for gently cooling while dehumidifying your room.
- You cannot heat the room during Dry mode.
- During Dry mode, the unit will operate at low speed; in order to adjust room humidity, the indoor unit's fan may stop from time to time. Also, the fan may operate at very low speed when detecting room humidity.
- The fan speed cannot be changed manually when Dry mode has been selected.

Fan: ● Use to circulate the air from ceiling area throughout your room when using space heaters.

During Cooling/Dry mode:

Set the thermostat to a temperature setting that is lower than the current room temperature. The Cooling and Dry modes will not operate if the thermostat is set higher than the actual room temperature (in Cooling mode, the fan alone will operate).

During Fan mode:

- Fan operation begins when room temperature in the vicinity of the air conditioner rises above the set thermostat temperature; when the temperature drops, fan operation stops.
- If the air emitted feels too cool, raise the thermostat setting.

TIMER OPERATION

To Use the OFF TIMER

- 1 Press the START/STOP button (Fig. 6 28) (if the unit is already operating, proceed to step 2).**

The Indoor Unit's OPERATION Indicator Lamp (red) (Fig. 3 5) will light.

- 2 Press OFF TIMER button (Fig. 6 23) to select the desired times.**

Press OFFTIMER button to change from temperature setting to timer display.

Each time the button is pressed, the time changes in the following order:

→ 0.5 → 1.0 → 1.5 → 2.0 → 9.0 → 9.5 → 10 → 11 → 12 (hour) ←

Set the time while the OFF TIMER mark (⊕▶○) on the Remote Controller's display is flashing. (The flashing will continue for about 30 seconds)

- 3 Press SET button (Fig. 6 25) to select OFF TIMER operation.**

The OFF Timer Mark (⊕▶○) will be shown on the Remote Controller's display.

The Indoor Unit TIMER Indicator Lamp (green) will light.
It can not be used during ONTIMER operation.

To Use the ON TIMER

- 1 Press the START/STOP button (Fig. 6 28) (if the unit is already operating, proceed to step 2).**

The Indoor Unit's OPERATION Indicator Lamp (red) (Fig. 3 5) will light.

- 2 Press ON TIMER button (Fig. 6 24) to set the expected time.**

If ONTIMER button is pressed, it will be changed into time display from temperature setting display.

Each time the button is pressed, the time time changes in the following order:

← 6.0 → 6.5 → 7.0 → ... → 9.0 → 9.5 → 10 → 11
5.5 ← 5.0 ← ... ← 1.0 ← 0.5 ← 12(hour) ←

Set the time while the ONTIMER mark (⊕▶|) on the Remote Controller's display is flashing. (The flashing will continue for about 30 seconds)

- 3 Press SET button (Fig. 6 25) to select ON TIMER operation.**

The ON Timer mark (⊕▶|) will be shown on the Remote Controller's display.

The Indoor Unit Timer Indicator Lamp (green) Will light.
It can not be used during OFFTIMER operation.

To Cancel the Timer

Press the CANCEL TIMER button.

To Change the Timer Settings

Press the ONTIMER button/OFFTIMER button as required. Perform Use TIMER step 2 and 3.

To Stop Air Conditioner Operation while the Timer is Operating

Press the START/STOP button.

To Change Operating Conditions

If you wish to change the operating conditions (Mode, Fan Speed, Thermostat Setting), after making the timer setting, wait until the entire display reappears, then press the appropriate buttons to change to the desired operating condition.

To Cancel the Timer

Press the CANCEL TIMER button.

To Change the Timer Settings

Press the ONTIMER button/OFFTIMER button as required. Perform Use TIMER step 2 and 3.

To Stop Air Conditioner Operation while the Timer is Operating

Press the START/STOP button.

To Change Operating Conditions

If you wish to change operating conditions (Mode, Fan Speed, Thermostat Setting), after making the timer setting wait until the entire display reappears, then press the appropriate buttons to change the operating condition desired.

SLEEP TIMER OPERATION

Unlike other timer functions, the SLEEP timer is used to set the length of time until air conditioner operate is stopped.

To Use the SLEEP timer

While the air conditioner is operating or stopped, press the SLEEP button (Fig. 6 ⑱).

The SLEEPTIMER mark (⤵⊕▶○) on the Remote Controller's display will light. Within 3 seconds after (⤵⊕▶○) light the time can be changed by pressing SLEEP button once again.

Each time the button is pressed, the time changes in the following order:

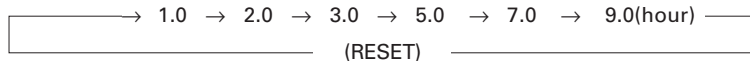

About three seconds later, the entire display will reappear. The Indoor Unit's OPERATION Indicator Lamp (red) (Fig. 3 ⑤) and theTIMER indicator lamp (green) (Fig. 3 ⑥) light.

To Cancel the Timer:

Press the CANCELTIMER button.

To Stop the Air Conditioner During Timer Operation:

Press the START/STOP button.

To Change the Timer Settings

Press the SLEEP button once to display the last setting time. Press the SLEEP button again to change the time.

Each time the button is pressed, the time changes in the following order (Change from the last setting time):

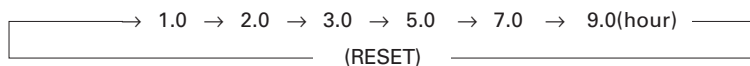

About the SLEEP timer

To prevent excessive cooling during sleep, the SLEEP timer function automatically modifies the thermostat setting in accordance with the time setting. When the set time has elapsed, the air conditioner completely stops.

During Cooling/Dry operation:

When the SLEEP timer is set, the thermostat setting is automatically raised 1 °C every sixty minutes. When the thermostat has been raised a total of 2 °C, the thermostat setting at that time is maintained until the set time has elapsed, at which time the air conditioner automatically turns off.

SLEEP timer setting

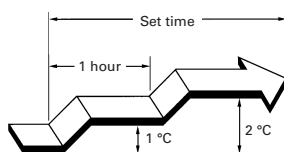

Confirmation of TIMER's time

To confirm each TIMER's time, press SET button while setting OFFTIMER, ONTIMER or SLEEPTIMER (or during running). If SET button is pressed, it will be changed into time display from temperature setting display. The left time of the TIMER which is being set currently will be displayed for 5 seconds, then it will return to temperature setting display.

ADJUSTING THE DIRECTION OF AIR CIRCULATION

Vertical (up-down) direction of airflow is adjusted by pressing the Remote Controller's AIR FLOW DIRECTION button. Horizontal (right-left) airflow direction is adjusted manually, by moving the Air Flow Direction Louvers.

Whenever making horizontal airflow adjustments, start air conditioner operation and be sure that the vertical air direction louvers are stopped.

Vertical Air Direction Adjustment

Press the AIR FLOW DIRECTION button (Fig. 6 ㉓).

Each time the button is pressed, the air direction range will change as follows:

③ ↔ ② ↔ ① ↔ ⑥ ↔ ⑤ ↔ ④

Types of Air flow Direction Setting:

①,②,③ : During Cooling/Dry modes

①,②,③,④,⑤,⑥ : During Fan mode

The Remote Controller's display does not change.

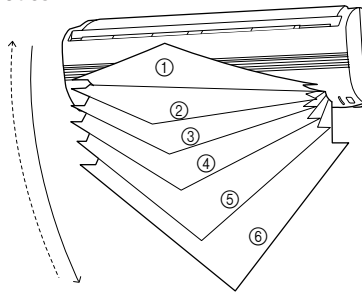

- Use the air direction adjustments within the ranges shown above.
- The vertical airflow direction is set automatically as shown, in accordance with the type of operation selected.
 - During Cooling/Dry mode : Horizontal flow ①
 - During Fan mode : Downward flow ⑤
- During AUTO mode operation, for the first minute after beginning operation, airflow will be horizontal ①; the air direction cannot be adjusted during this period.

⚠ DANGER!

- Never place fingers or foreign objects inside the outlet ports, since the internal fan operates at high speed and could cause personal injury.

- Always use the Remote Controller's AIR FLOW DIRECTION button to adjust the vertical airflow louvers. Attempting to move them manually could result in improper operation; in this case, stop operation and restart. The louvers should begin to operate properly again.

- During Cooling and Dry modes, do not move the vertical air direction louvers outside their proper operating range for the mode (① - ③) and into the fan region (④ - ⑥); using the louvers in the fan region will cause moisture to condense near the air outlet, and water may drop onto the floor. During the Cooling/Dry modes, if the louvers are operated outside the range ① - ③ for more than 30 minutes, they will be automatically returned to the ③ range.

- When used in a room with infants, children, elderly or sick persons, the air direction and room temperature should be considered carefully when making settings.

Right-Left Adjustment

Adjust the Right-Left louvers.

- Move the Right-Left louvers to adjust air flow in the direction you prefer.

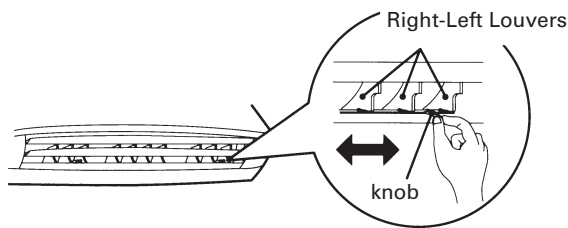

⚠ DANGER!

- When adjusting the Right-Left Louvers, it is necessary to stop the Air-Conditioner first and make sure that it stops completely before adjusting the direction.

SWING OPERATION

Begin air conditioner operation before performing this procedure.

To select SWING Operation

Press the SWING LOUVER button (Fig. 6 ⑩).

The SWING indicator lamp (orange) (Fig. 3 ⑦) will light.

In this mode, the Air Flow Direction Louvers will swing automatically to direct the air flow both up and down.

To Stop SWING Operation

Press the SWING LOUVER button (Fig. 6 ⑩) once again.

The SWING indicator lamp (orange) (Fig. 3 ⑦) will go out.

Airflow direction will return to the setting before swing was begun.

About Swing Operation

- The range of swing is relative to the currently set airflow direction.
- During Cooling/Dry modes, if SWING Operation is continued at the lowest (downward) range for more than 30 minutes, the unit will automatically switch the swing range to the horizontal flow range, to prevent the condensation of moisture on the outlet.
- The SWING operation may stop temporarily when the air conditioner's fan is not operating, or when operating at very low speeds.

MANUAL AUTO OPERATION

Use the MANUAL AUTO operation in the event the Remote Controller is lost or otherwise unavailable.

How To Use the Main Unit Controls

Press the MANUAL AUTO button (Fig. 2 ②) on the main unit control panel.

To stop operation, press the MANUAL AUTO button once again. (Controls are located inside the Intake Grille)

- When the air conditioner is operated with the controls on the Main Unit, it will operate under the same mode as the AUTO mode selected on the Remote Controller (see page 6).
- The fan speed selected will be "AUTO" and the thermostat setting will be standard.

CLEANING AND CARE

CAUTION!

- Before cleaning the air conditioner, be sure to turn it off and disconnect the Power Supply Cord.
- Be sure the Intake Grille (Fig. 1 ㉓) is installed securely.
- When removing and replacing the air filters, be sure not to touch the heat exchanger, as personal injury may result.

Cleaning the Intake Grille

1. Remove the Intake Grille.

- ① Place your fingers at both lower ends of the grille panel, and lift forward; if the grille seems to catch partway through its movement, continue lifting upward to remove.
- ② Pull past the intermediate catch and open the Intake Grille wide so that it become horizontal.

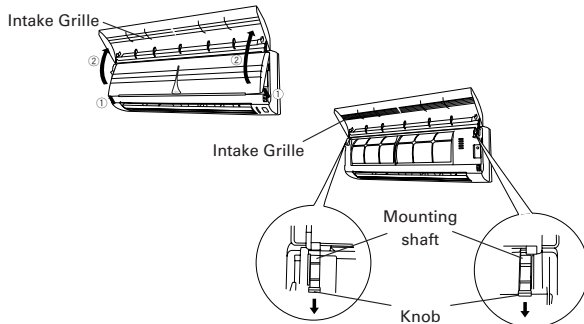

2. Clean with water.

Remove dust with a vacuum cleaner; wipe the unit with warm water, then dry with a clean, soft cloth.

3. Replace the Intake Grille.

- ① Pull the knobs all the way.
- ② Hold the grille horizontal and set the left and right mounting shafts into the bearings at the top of the panel.

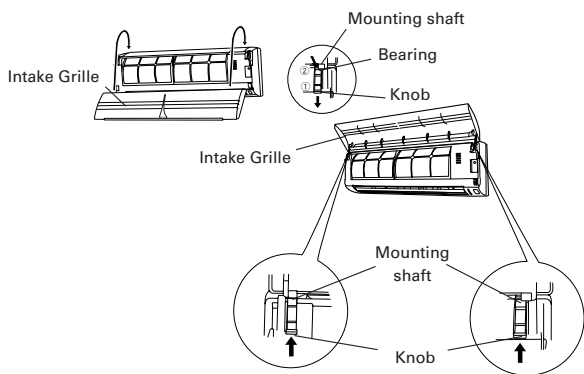

Cleaning the Air Filter

1. Open the Intake Grille, and remove the air filter.

Lift up the air filter's handle, disconnect the two lower tabs, and pull out.

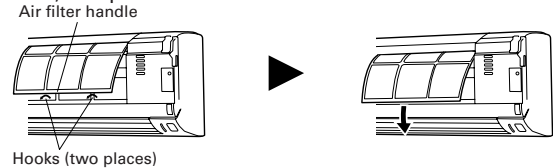

2. Remove dust with a vacuum cleaner or by washing.

After washing, allow to dry thoroughly in a shaded place.

3. Replace the Air Filter and close the Intake Grille.

- ① Align the sides of the Air Filter with the panel, and push in fully, making sure the two lower tabs are returned properly to their holes in the panel.



- ② Close the Intake Grille.

(For purposes of example, the illustration shows the unit without Intake Grille installed.)

- Dust can be cleaned from the Air Filter either with a vacuum cleaner, or by washing the filter in a solution of mild detergent and warm water. If you wash the filter, be sure to allow it to dry thoroughly in a shady place before reinstalling.
- If dirt is allowed to accumulate on the Air Filter, air flow will be reduced, lowering operating efficiency and increasing noise.
- During periods of normal use, the Air Filters should be cleaned every two weeks.

When using the optional Air Cleaning Filter

- Install the optional Air Cleaning Filter set (APS-03B) as instructed (installation instructions are furnished with the Air Cleaning Filter set).

- When used for extended periods, the unit may accumulate dirt inside, reducing its performance. We recommend that the unit be inspected regularly, in addition to your own cleaning and care. For more information, consult authorized service personnel.
- When cleaning the unit's body, do not use water hotter than 40 °C, harsh abrasive cleansers, or volatile agents like benzene or thinner.
- Do not expose the unit body to liquid insecticides or hairsprays.
- When shutting down the unit for one month or more, first allow the fan mode to operate continuously for about one-half day to allow internal parts to dry thoroughly.

TROUBLESHOOTING

WARNING!

In the event of a malfunction (burning smell, etc.), immediately stop operation, disconnect the Power Supply Plug, and consult authorized service personnel.
 Merely turning off the unit's power switch will not completely disconnect the unit from the power source. Always be sure to disconnect the Power Supply Plug or turn off your circuit breaker to ensure that power is completely off.

Before requesting service, perform the following checks:

	Symptom	Problem	See Page
NORMAL FUNCTION	Doesn't operate immediately:	<ul style="list-style-type: none"> ● If the unit is stopped and then immediately started again, the compressor will not operate for about 3 minutes, in order to prevent fuse blowouts. ● Whenever the Power Supply Plug is disconnected and then re-connected to a power outlet, the protection circuit will operate for about 3 minutes, preventing unit operation during that period. 	—
	Noise is heard:	<ul style="list-style-type: none"> ● During operation and immediately after stopping the unit, the sound of water flowing in the air conditioner's piping may be heard. Also, noise may be particularly noticeable for about 2 to 3 minutes after starting operation (sound of coolant flowing). ● During operation, a slight squeaking sound may be heard. This is the result of minute expansion and contraction of the front cover due to temperature changes. 	—
	Smells:	<ul style="list-style-type: none"> ● Some smell may be emitted from the indoor unit. This smell is the result of room smells (furniture, tobacco, etc.) which have been taken into the air conditioner. 	—
	Mist or steam are emitted:	<ul style="list-style-type: none"> ● During Cooling or Dry operation, a thin mist may be seen emitted from the indoor unit. This results from the sudden Cooling of room air by the air emitted from the air conditioner, resulting in condensation and misting. 	—
	Airflow is weak or stops:	<ul style="list-style-type: none"> ● The fan may operate at very low speed during Dry operation or when the unit is monitoring the room's temperature. 	5
		<ul style="list-style-type: none"> ● During SUPER QUIET operation, the fan will operate at very low speed. 	5
<ul style="list-style-type: none"> ● In the monitor AUTO operation, the fan will operate at very low speed. 		5	

TROUBLESHOOTING

	Symptom	Items to check	See Page
CHECK ONCE MORE	Doesn't operate at all:	<ul style="list-style-type: none"> ● Is the Power Supply Plug disconnected its outlet? ● Has there been a power failure? ● Has a fuse blown out, or a circuit breaker been tripped? 	—
		<ul style="list-style-type: none"> ● Is the timer operating? 	7 - 8
	Poor Cooling performance:	<ul style="list-style-type: none"> ● Is the air filter dirty? ● Air the air conditioner's intake grille or outlet port blocked? ● Did you adjust the room temperature settings (thermostat) correctly? ● Is there a window or door open? ● In the case of Cooling operation, is a window allowing bright sunlight to enter? (Close the curtains.) ● In the case of Cooling operation, are there heating apparatus and computers inside the room, or are there too many people in the room? 	—
		<ul style="list-style-type: none"> ● Is the unit set for SUPER QUIET operation? 	5
The unit operates differently from the Remote Controller's setting:	<ul style="list-style-type: none"> ● Are the Remote Controller's batteries dead? ● Are the Remote Controller's batteries loaded properly? 	4	

If the problem persists after performing these checks, or if you notice burning smells, or the TIMER indicator Lamp (Fig. 3 ⑥) flashes, immediately stop operation, disconnect the Power Supply Plug (Fig. 1 ⑬), and consult authorized service personnel.

OPERATING TIPS

AUTO Restart

In Event of Power Interruption

- The air conditioner power has been interrupted by a power failure. The air conditioner will then restart automatically in its previous mode when the power is restored.
- Operated by setting before the power failure.
- If a power failure occurs during TIMER operation, the timer will be reset and the unit will begin (or stop) operation at the new time setting. In the event that this (kind of timer fault occurs the TIMER Indicator Lamp will flash (see Page. 3).
- Use of other electrical appliances (electric shaver, etc.) or nearby use of a wireless radio transmitter may cause the air conditioner to malfunction. In this event, temporarily disconnect the Power Supply Plug, reconnect it, and then use the Remote Controller to resume operation.

OPERATING TIPS

Temperature and Humidity Range

	Cooling Mode	Dry Mode
Outdoor temperature	About 21-43 °C	About 21-43 °C
Indoor temperature	About 18-32 °C	About 18-32 °C

- If the air conditioner is used under higher temperature conditioner than those listed, the built-in protection circuit may operate to prevent internal circuit damage. Also, during Cooling and Dry modes, if the unit is used under conditions of lower temperature than those listed above, the heat-exchanger may freeze, leading to water leakage and other damage.
- Do not use this unit for any purposes other than the Cooling, Dehumidifying, and air-circulation of rooms in ordinary dwellings.
- If the unit is used for long periods under high-humidity conditions, condensation may form on the surface of the indoor unit, and drip onto the floor or other objects underneath. (About 80% or more)
- Acoustic Noise Information
The maximum sound pressure level is less than 70 dB (A) for both indoor unit and outdoor unit. According to IEC 704-1 and ISO 3744.

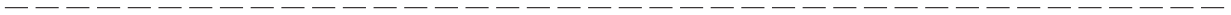
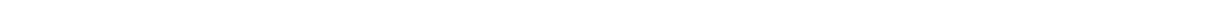
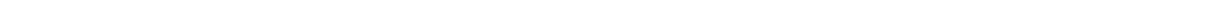
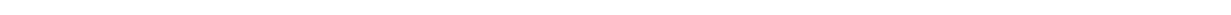
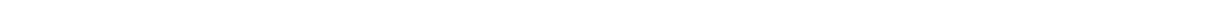
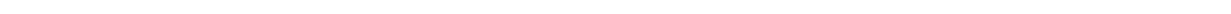
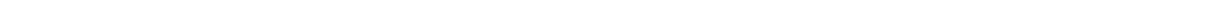
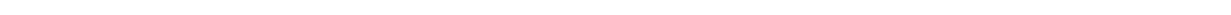
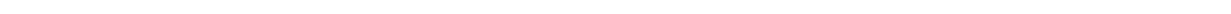
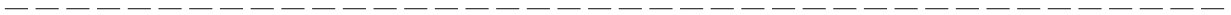

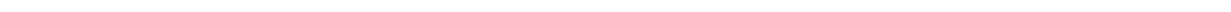
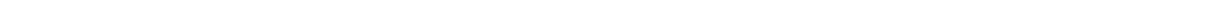
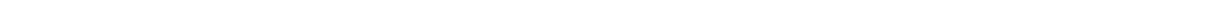
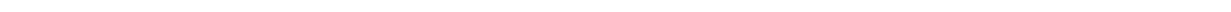
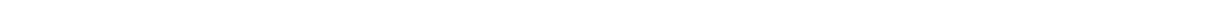
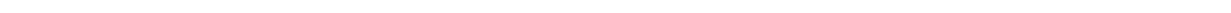
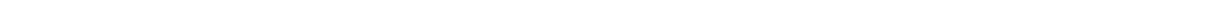
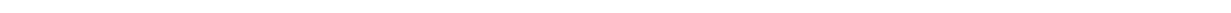
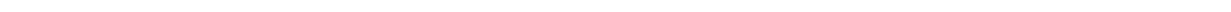
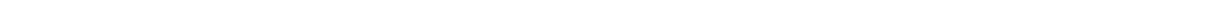
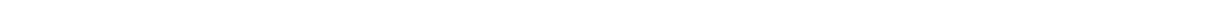



TYPE TYP TYPE TIPO ΤΥΠΟΣ	COOLING MODEL FÜR KÜHLEN MODÈLE REFRIGÉRISSANT MODELO DE REFRIGERACIÓN MODELO PER RAFFREDDAMENTO ΜΟΝΤΕΛΟ ΨΥΞΕΩΣ
--------------------------------------	--

SPECIFICATIONS	
POWER SUPPLY 230 V-50 Hz	MAX. PRESSURE
COOLING	SUCTION 1,160 kPa
CAPACITY 2,75 kW	DISCHARGE 4,120 kPa
INPUT POWER 1,05 kW	REFRIGERANT R410A 590 g
CURRENT 4,7 A	DIMENSIONS & WEIGHT
ENERGY EFFICIENCY RATIO 2,62	INDOOR UNIT
MAX. CURRENT	Height/Width/Depth 257/808/187 mm
Cooling 5,8 A	Weight 8,0 kg (NET)
	OUTDOOR UNIT
	Height/Width/Depth 535/695/250 mm
	Weight 30 kg (NET)

TECHNISCHE DATEN	
STROMVERSORGUNG 230 V-50 Hz	HÖCHSTZULÄSSIGER DRUCK
KÜHLBETRIEB	ANSAUGEN 1.160 kPa
KÜHLLEISTUNG 2,75 kW	ABGABE 4.120 kPa
LEISTUNGS-AUFNAHME 1,05 kW	KÄLTEMITTEL R410A 590 g
NENNSTROM 4,7 A	ABMESSUNGEN UND GEWICHT
WIRKUNGSGRADZAHL 2,62	INNENGERÄT
MAX. STROMSTÄRKE	Höhe/Breite/Tiefe 257/808/187 mm
Kühlbetrieb 5,8 A	Gewicht 8,0 kg (netto)
	AUßENGERÄT
	Höhe/Breite/Tiefe 535/695/250 mm
	Gewicht 30 kg (netto)
	● Enthält ozonabbauenden FCKW.

FICHE TECHNIQUE	
ALIMENTATION 230 V-50 Hz	PRESSION MAXIMALE
REFROIDISSEMENT	ASPIRATION 1.160 kPa
PUISSANCE FRIGORIFIQUE 2,75 kW	REFOULEMENT 4.120 kPa
PUISSANCE ABSORBÉE 1,05 kW	RÉFRIGÉRIANT R410A 590 g
INTENSITÉ 4,7 A	DIMENSIONS ET POIDS
EFFICACITÉ FRIGORIFIQUE 2,62	UNITÉ INTÉRIEURE
INTENSITÉ MAXIMALE	H/L/P 257/808/187 mm
Refroidissement 5,8 A	Poids 8,0 kg (NET)
	UNITÉ EXTÉRIEURE
	H/L/P 535/695/250 mm
	Poids 30 kg (NET)

TYPE TYP TYPE TIPO ΤΥΠΟΣ	COOLING MODEL FÜR KÜHLEN MODÈLE REFRIGÉRISSANT MODELO DE REFRIGERACIÓN MODELO PER RAFFREDDAMENTO ΜΟΝΤΕΛΟ ΨΥΞΕΩΣ
--------------------------------------	--

SPECIFICATIONS	
POWER SUPPLY 230 V-50 Hz	MAX. PRESSURE
COOLING	SUCTION 1,160 kPa
CAPACITY 3,4 kW	DISCHARGE 4,120 kPa
INPUT POWER 1,33 kW	REFRIGERANT R410A 720 g
CURRENT 6,2 A	DIMENSIONS & WEIGHT
ENERGY EFFICIENCY RATIO 2,56	INDOOR UNIT
MAX. CURRENT	Height/Width/Depth 257/808/187 mm
Cooling 7,3 A	Weight 8,0 kg (NET)
	OUTDOOR UNIT
	Height/Width/Depth 535/695/250 mm
	Weight 32 kg (NET)

TECHNISCHE DATEN	
STROMVERSORGUNG 230 V-50 Hz	HÖCHSTZULÄSSIGER DRUCK
KÜHLBETRIEB	ANSAUGEN 1.160 kPa
KÜHLLEISTUNG 3,4 kW	ABGABE 4.120 kPa
LEISTUNGS-AUFNAHME 1,33 kW	KÄLTEMITTEL R410A 720 g
NENNSTROM 6,2 A	ABMESSUNGEN UND GEWICHT
WIRKUNGSGRADZAHL 2,56	INNENGERÄT
MAX. STROMSTÄRKE	Höhe/Breite/Tiefe 257/808/187 mm
Kühlbetrieb 7,3 A	Gewicht 8,0 kg (netto)
	AUßENGERÄT
	Höhe/Breite/Tiefe 535/695/250 mm
	Gewicht 32 kg (netto)
	● Enthält ozonabbauenden FCKW.

FICHE TECHNIQUE	
ALIMENTATION 230 V-50 Hz	PRESSION MAXIMALE
REFROIDISSEMENT	ASPIRATION 1.160 kPa
PUISSANCE FRIGORIFIQUE 3,4 kW	REFOULEMENT 4.120 kPa
PUISSANCE ABSORBÉE 1,33 kW	RÉFRIGÉRIANT R410A 720 g
INTENSITÉ 6,2 A	DIMENSIONS ET POIDS
EFFICACITÉ FRIGORIFIQUE 2,56	UNITÉ INTÉRIEURE
INTENSITÉ MAXIMALE	H/L/P 257/808/187 mm
Refroidissement 7,3 A	Poids 8,0 kg (NET)
	UNITÉ EXTÉRIEURE
	H/L/P 535/695/250 mm
	Poids 32 kg (NET)